



UNIVERSITY OF CAMBRIDGE INTERNATIONAL EXAMINATIONS  
General Certificate of Education Ordinary Level

**PHYSICS**

**5054/11**

Paper 1 Multiple Choice

**October/November 2012**

**1 hour**

Additional Materials: Multiple Choice Answer Sheet  
Soft clean eraser  
Soft pencil (type B or HB is recommended)



**READ THESE INSTRUCTIONS FIRST**

Write in soft pencil.

Do not use staples, paper clips, highlighters, glue or correction fluid.

Write your name, Centre number and candidate number on the Answer Sheet in the spaces provided unless this has been done for you.

There are **forty** questions on this paper. Answer **all** questions. For each question there are four possible answers **A, B, C** and **D**.

Choose the **one** you consider correct and record your choice in **soft pencil** on the separate Answer Sheet.

**Read the instructions on the Answer Sheet very carefully.**

Each correct answer will score one mark. A mark will not be deducted for a wrong answer.  
Any rough working should be done in this booklet.

This document consists of **16** printed pages.



- 1 Vernier calipers read to one tenth of a millimetre.

Which reading is given to this precision?

- A 3.3 cm      B 3.31 cm      C 3.310 cm      D 3.312 cm

- 2 Velocity is given by the change in displacement divided by the change in time.

How many vector quantities appear in this statement?

- A 0      B 1      C 2      D 3

- 3 A ball starts to roll down a steep slope and then along rough horizontal ground.

Which graph best shows the **speed** of the ball?

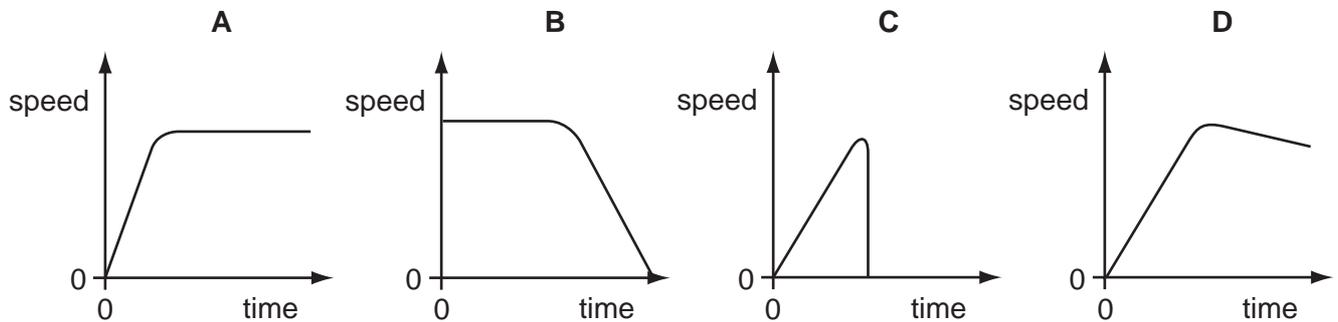

- 4 A car is stationary at a set of traffic lights.

When the lights turn green, the car begins to move and continues to speed up until it reaches the maximum speed allowed. It continues to travel at this constant speed for the rest of the journey.

What happens to the acceleration and to the velocity of the car during this journey?

- A Both the acceleration and the velocity change.  
 B Only the acceleration changes.  
 C Only the velocity changes.  
 D Neither the acceleration nor the velocity changes.

- 5 An aeroplane is half way along a runway before it takes off.

The arrows show the directions of four forces acting on the aeroplane.

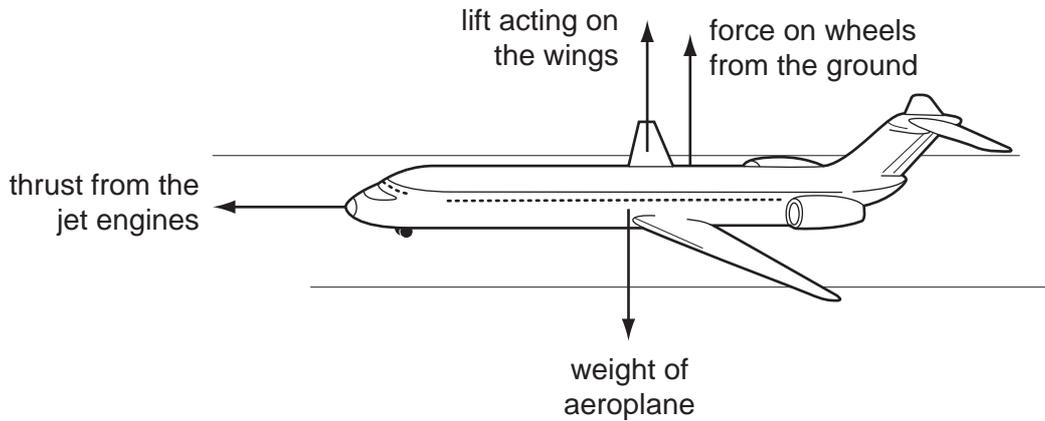

The drag forces on the aeroplane are negligible.

The gravitational field strength  $g$  is  $10 \text{ N/kg}$ .

The acceleration of the aeroplane is  $2 \text{ m/s}^2$ .

What is the largest force?

- A the force on the wheels from the ground
- B the lift acting on the wings
- C the thrust from the jet engines
- D the weight of the aeroplane

- 6 The front wheel of a car is turned in a clockwise direction by the engine as the car accelerates towards the right, as shown in the diagram. There is a force of friction between the wheel and the road.

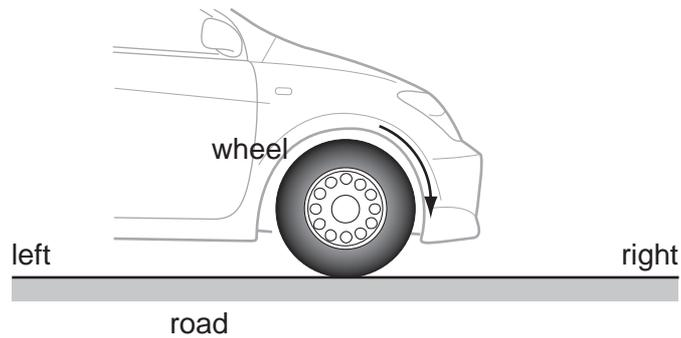

What are the directions of the frictional forces on the wheel of the car and on the road?

	direction of frictional force on wheel	direction of frictional force on road
<b>A</b>	to the left	to the left
<b>B</b>	to the left	to the right
<b>C</b>	to the right	to the left
<b>D</b>	to the right	to the right

- 7 Masses *X* and *Y* are placed on opposite sides of the centre of a uniform metre rule, which is pivoted at its centre.

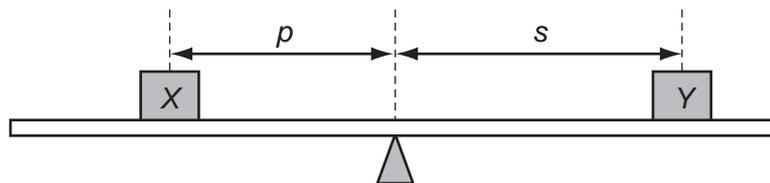

Which combination of masses and distances balances the rule?

	mass/g		distance/cm	
	<i>X</i>	<i>Y</i>	<i>p</i>	<i>s</i>
<b>A</b>	200	200	5	10
<b>B</b>	200	300	10	15
<b>C</b>	400	300	12	16
<b>D</b>	500	200	15	30

- 8 A student balances a non-uniform object on a pivot. To do this, a weight is suspended near the left-hand end of the object.

Where is the centre of mass of the object?

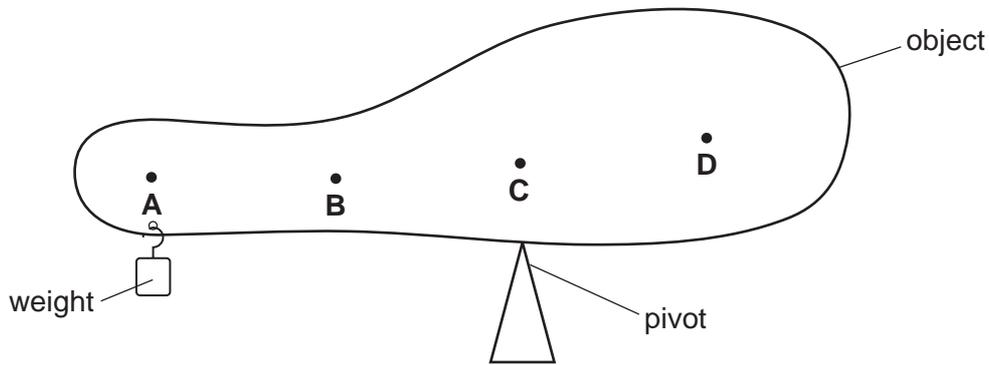

- 9 A spring has a length of 9 cm when loaded with a 200 g mass. The extension-mass graph for the spring is shown.

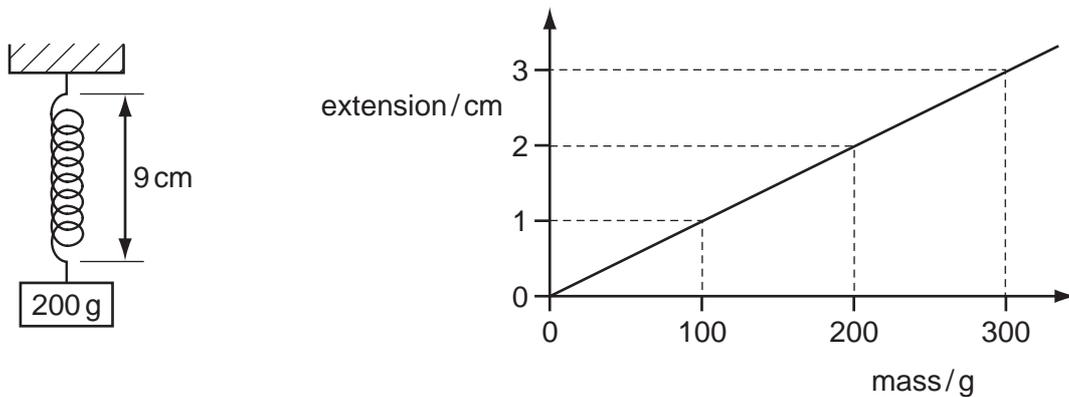

The 200 g mass is replaced with a 100 g mass. What is the new length of the spring?

- A 7 cm      B 8 cm      C 9 cm      D 10 cm
- 10 The diagram shows two cubes made from the same material. One cube has sides that are twice as long as the sides of the other cube.

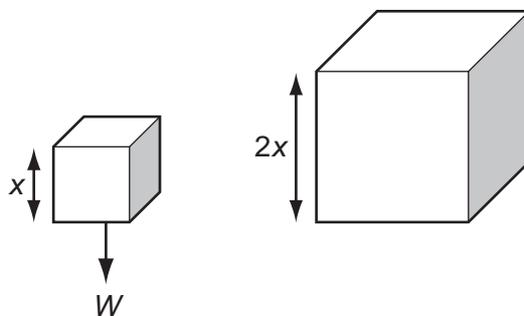

The weight of the small cube is  $W$ .

What is the weight of the larger cube?

- A  $2W$       B  $4W$       C  $8W$       D  $16W$

- 11 A garden table weighs 40 N and has a top surface of area  $2 \text{ m}^2$ . It is raining and the rain produces a pressure of  $4 \text{ N/m}^2$  on the table.

What is the force exerted by the table on the ground?

- A** 20 N                      **B** 32 N                      **C** 42 N                      **D** 48 N

- 12 Four syringes contain air at atmospheric pressure.

The air in all four syringes is slowly compressed. The results are given in the table.

Which syringe shows the smallest pressure change?

	volume before compression / $\text{cm}^3$	volume after compression / $\text{cm}^3$
<b>A</b>	50	10
<b>B</b>	100	50
<b>C</b>	400	25
<b>D</b>	400	100

- 13 Which is a non-renewable source of energy?

- A** a battery in a watch  
**B** a hydroelectric power station  
**C** a solar panel  
**D** a wind turbine

- 14 A builder lifts eight slabs from the ground on to the back of a lorry 1.5 m high.

The total time taken is 48 s and each slab weighs 20 N.

How much useful power does the builder produce?

- A** 5 W                      **B** 40 W                      **C** 240 W                      **D** 320 W

- 15 When a gas is rapidly compressed to a smaller volume, its temperature increases.

What happens to the gas molecules?

- A** They move closer together and their average speed decreases.  
**B** They move closer together and their average speed increases.  
**C** They move closer together and their average speed remains unchanged.  
**D** They stay the same distance apart and their average speed increases.

- 16 On a hot day, the drink in a bottle can be kept cool by standing the bottle in a bowl of water and placing a wet cloth over it.

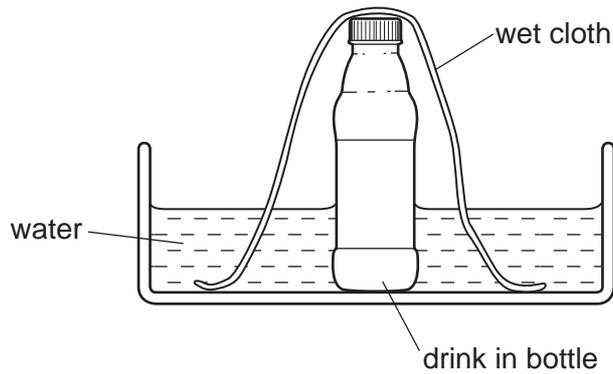

Why is the drink kept cool?

- A Hot air cannot escape from the bottle.
  - B The cloth conducts heat from the bottle into the water.
  - C The drink cannot evaporate from the bottle.
  - D Water evaporating from the cloth cools the drink.
- 17 A student uses a double-walled glass vessel to contain a hot liquid.

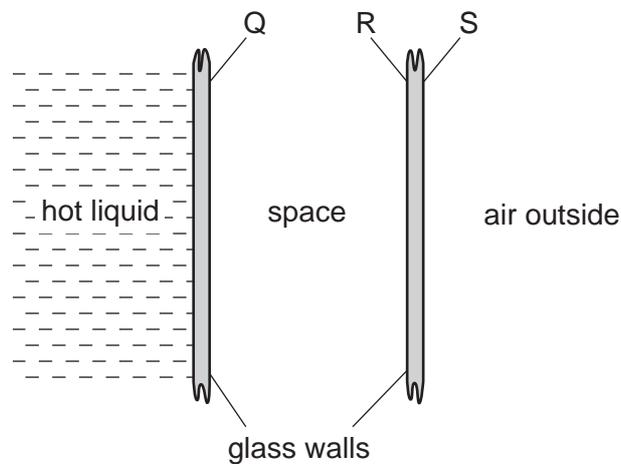

What reduces the heat loss by radiation?

- A a vacuum in the space between the walls
- B painting surface Q black
- C painting surface R black
- D painting surface S silver

18 What is the reason for the constriction in a clinical thermometer?

- A to give the thermometer a smaller temperature range
- B to make the thermometer more sensitive
- C to prevent the mercury breaking the bulb when it expands
- D to stop the mercury from going back to the bulb

19 Less heat is needed to raise the temperature of 1 kg of copper by  $1^{\circ}\text{C}$  than is needed to raise the temperature of 1 kg of water by  $1^{\circ}\text{C}$ .

Which statement explains this?

- A Copper has a higher melting point.
- B Copper has a lower specific heat capacity.
- C Copper has a smaller specific latent heat.
- D Copper is a better conductor of heat.

20 A person cannot unscrew the metal lid of a pot of jam. The lid can be unscrewed after it has been held under hot, running water for a few seconds.

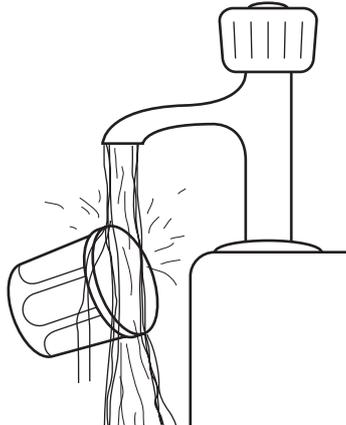

Why is this?

- A The air pressure in the jar falls.
- B The glass expands.
- C The jam melts.
- D The metal lid expands.

21 The diagram shows the pattern of waves in a ripple tank.

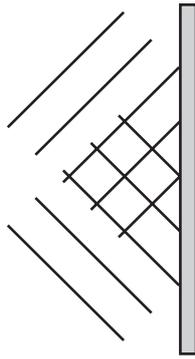

What does the pattern show?

- A waves being reflected
- B waves being refracted
- C waves changing frequency
- D waves changing speed

22 An object O is placed in front of a plane mirror.

Which diagram correctly represents the image I formed by the mirror?

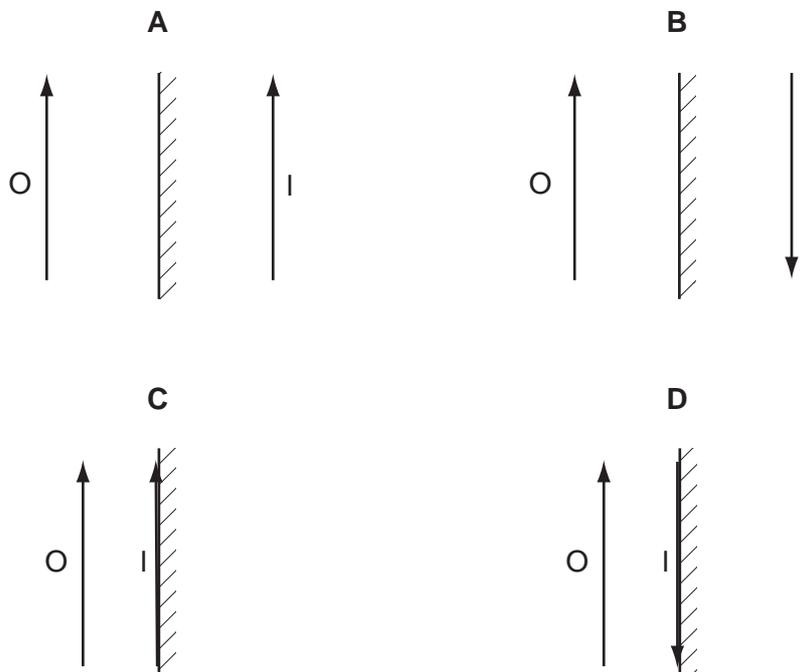

23 In the following diagrams, the angle  $c$  is the critical angle.

Which diagram shows the correct path of the light ray?

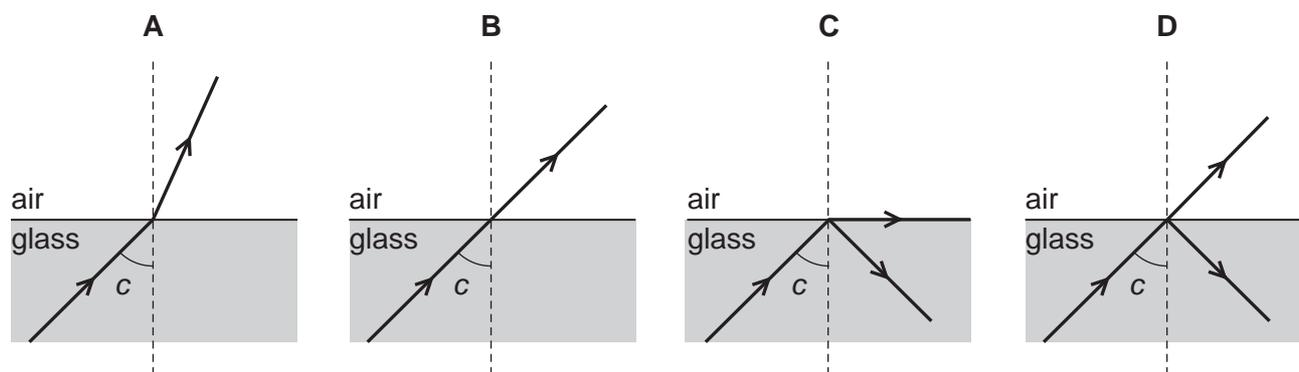

24 An object of height 1.5 cm is placed in front of a converging lens of focal length 2.0 cm.

The arrangement is shown on the full-scale ray diagram.

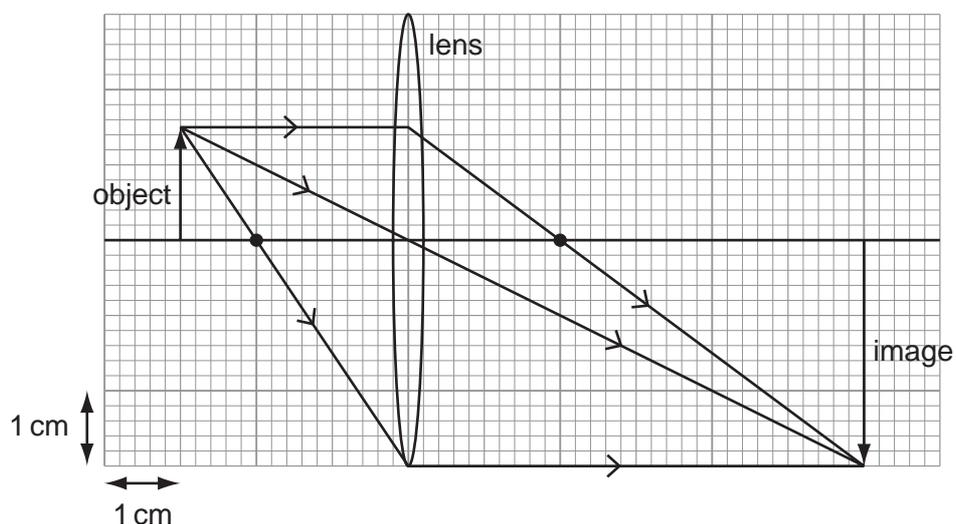

What is the linear magnification produced by the lens?

- A 2.0                      B 3.0                      C 4.0                      D 6.0

25 Red and violet are the colours at the ends of the visible spectrum.

How do the frequencies and the wavelengths of these colours compare?

	higher frequency	longer wavelength
A	red	red
B	red	violet
C	violet	red
D	violet	violet

- 26 A vertical wire passes at right angles through a piece of card. There is a large current in the wire in the direction shown.

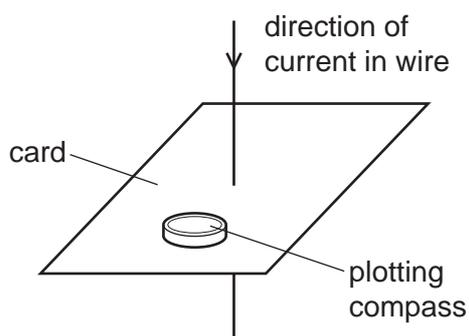

A plotting compass is placed on the card.

Which diagram shows the direction in which the needle of the plotting compass points?

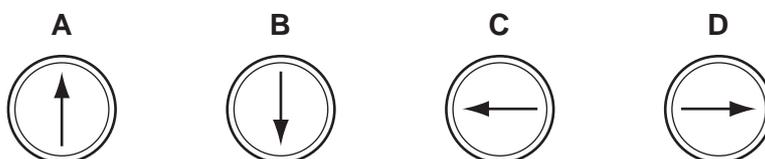

- 27 A positively-charged rod is brought near to an isolated uncharged conducting sphere.

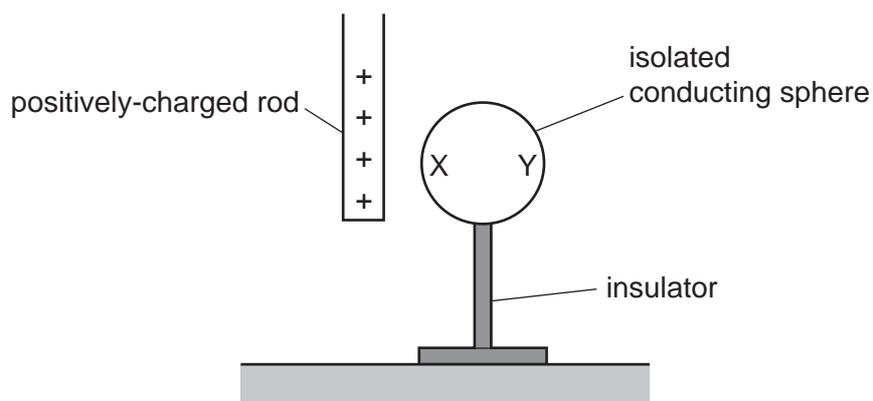

What are the charges on sides X and Y of the sphere?

- A Both X and Y are positively charged.
- B Both X and Y are negatively charged.
- C X is positively charged and Y is negatively charged.
- D X is negatively charged and Y is positively charged.

28 Three identical cells are connected in parallel to a resistor.

What is the advantage of using three cells in parallel, rather than a single cell?

- A Each cell produces more energy.
- B Each cell supplies more charge.
- C Each cell takes longer to run down.
- D The total electromotive force (e.m.f.) is larger.

29 The diagram shows three resistors in parallel.

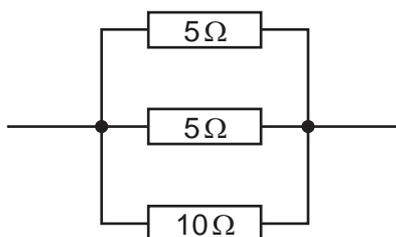

What is the combined resistance?

- A  $0.50\ \Omega$
- B  $2.0\ \Omega$
- C  $20\ \Omega$
- D  $250\ \Omega$

30 Which circuit contains a fuse and a rectifying diode?

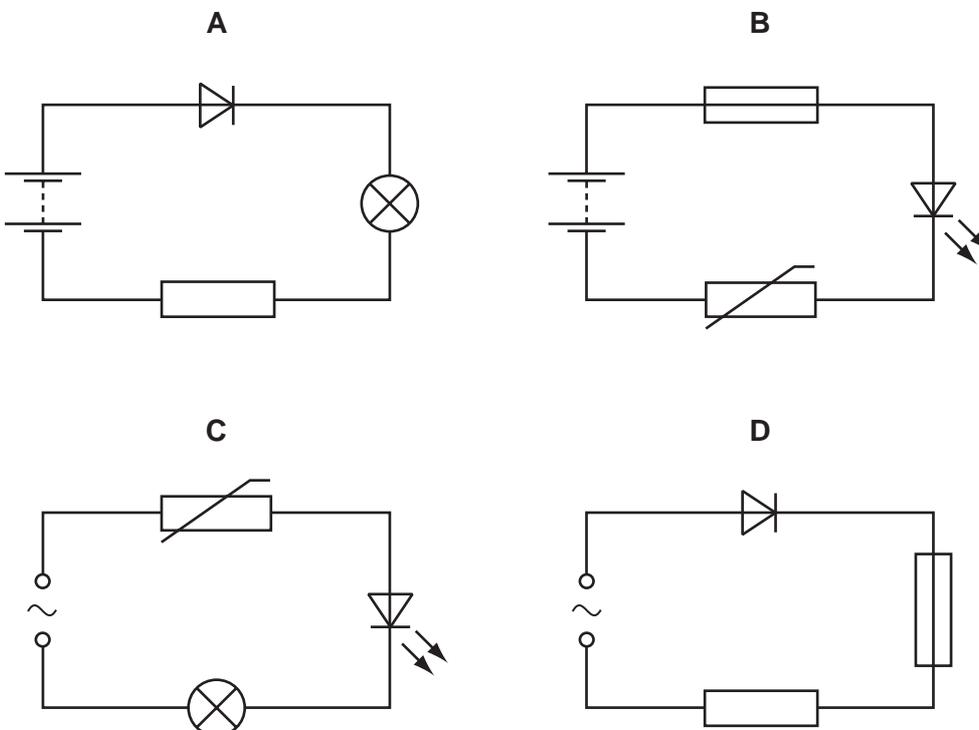

31 A lamp connected to a 12V supply converts energy at a rate of 36W.

How much energy will be converted in 10s?

- A 30J                      B 36J                      C 120J                      D 360J

32 An immersion heater is labelled 12V, 60W.

What is the current in the heater when connected to a 12V supply?

- A 0.20A                      B 5.0A                      C 12A                      D 60A

33 Each of the diagrams shows a cross-section through two parallel, current-carrying conductors.

Which diagram shows the shape of the magnetic field pattern **and** the directions of the forces on the two conductors?

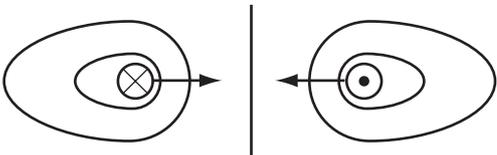
A 

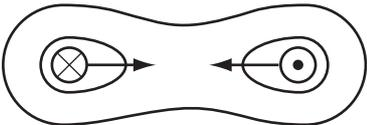
B 

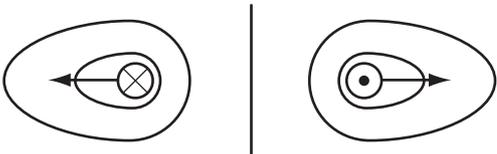
C 

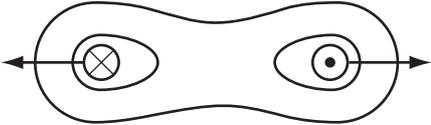
D 

key  
 conductor carrying current into page  
 conductor carrying current out of page

34 The diagram shows a simple d.c. motor.

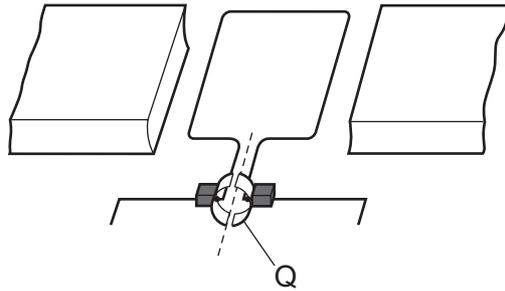

What is the part labelled Q?

- A a coil
- B a magnet
- C a slip ring
- D a split-ring commutator

35 The diagram shows the N-pole of a magnet moving into, and out of, a coil of wire.

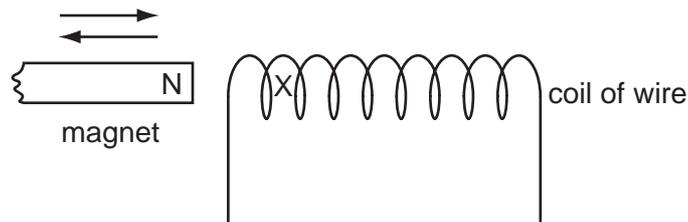

This movement produces a current in the coil of wire. The current produces a magnetic pole at X.

Which pole is produced at X when the magnet is moved in and when it is moved out?

	magnet moved in	magnet moved out
<b>A</b>	N	N
<b>B</b>	N	S
<b>C</b>	S	N
<b>D</b>	S	S

36 A simple a.c. generator produces an alternating e.m.f. as shown.

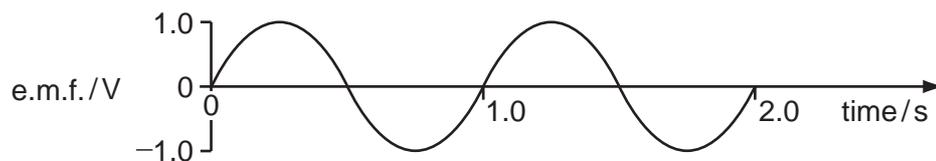

The speed of the generator is doubled.

Which graph best represents the new output?

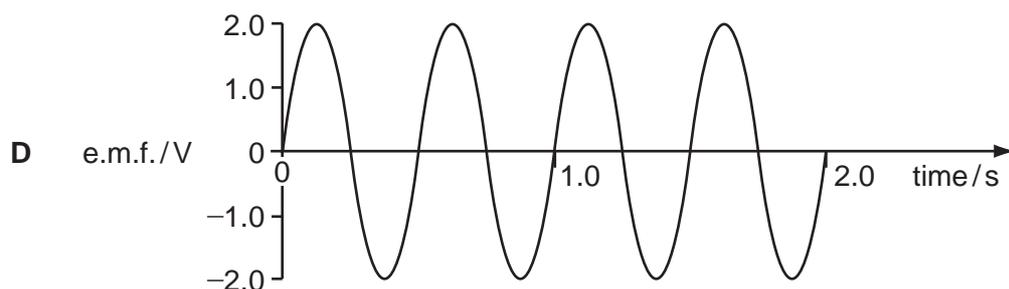
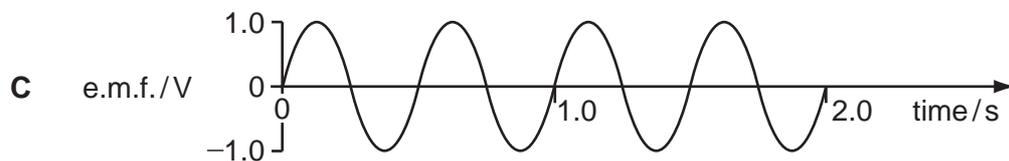
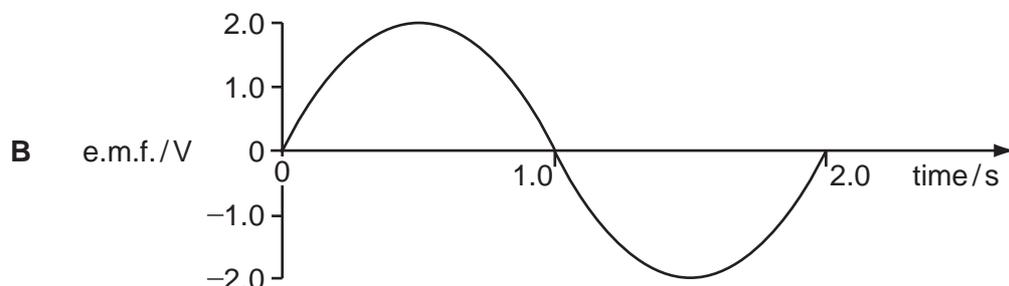
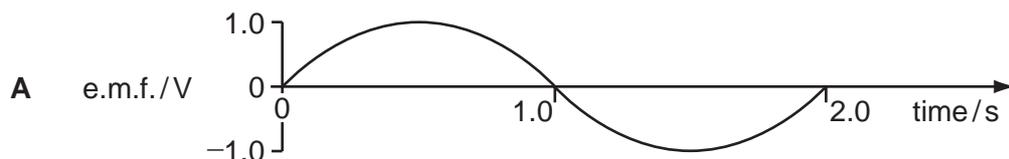

37 What is required to operate a reed relay in a switching circuit?

- A** a capacitor
- B** an electric field
- C** a magnetic field
- D** a transformer

38 In the simple model of an atom, X orbits around Y.

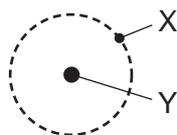

What are X and Y?

	X	Y
<b>A</b>	electron	nucleus
<b>B</b>	neutron	electron
<b>C</b>	nucleus	proton
<b>D</b>	proton	neutron

39 In nuclear .....1....., hydrogen nuclei .....2..... to form helium nuclei, releasing energy.

Which words correctly complete gaps 1 and 2?

	1	2
<b>A</b>	fission	join together
<b>B</b>	fission	split apart
<b>C</b>	fusion	join together
<b>D</b>	fusion	split apart

40 Which nucleus is produced when thorium-223 ( ${}_{90}^{223}\text{Th}$ ) emits an alpha-particle?

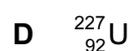
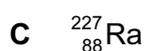
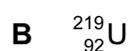

Permission to reproduce items where third-party owned material protected by copyright is included has been sought and cleared where possible. Every reasonable effort has been made by the publisher (UCLES) to trace copyright holders, but if any items requiring clearance have unwittingly been included, the publisher will be pleased to make amends at the earliest possible opportunity.

University of Cambridge International Examinations is part of the Cambridge Assessment Group. Cambridge Assessment is the brand name of University of Cambridge Local Examinations Syndicate (UCLES), which is itself a department of the University of Cambridge.