CHEMISTRY

9701/42

Paper 4 A Level Structured Questions

October/November 2018

MARK SCHEME

Maximum Mark: 100

Published

This mark scheme is published as an aid to teachers and candidates, to indicate the requirements of the examination. It shows the basis on which Examiners were instructed to award marks. It does not indicate the details of the discussions that took place at an Examiners' meeting before marking began, which would have considered the acceptability of alternative answers.

Mark schemes should be read in conjunction with the question paper and the Principal Examiner Report for Teachers.

Cambridge International will not enter into discussions about these mark schemes.

Cambridge International is publishing the mark schemes for the October/November 2018 series for most Cambridge IGCSE™, Cambridge International A and AS Level components and some Cambridge O Level components.

This document consists of **13** printed pages.

PUBLISHED**Generic Marking Principles**

These general marking principles must be applied by all examiners when marking candidate answers. They should be applied alongside the specific content of the mark scheme or generic level descriptors for a question. Each question paper and mark scheme will also comply with these marking principles.

GENERIC MARKING PRINCIPLE 1:

Marks must be awarded in line with:

- the specific content of the mark scheme or the generic level descriptors for the question
- the specific skills defined in the mark scheme or in the generic level descriptors for the question
- the standard of response required by a candidate as exemplified by the standardisation scripts.

GENERIC MARKING PRINCIPLE 2:

Marks awarded are always **whole marks** (not half marks, or other fractions).

GENERIC MARKING PRINCIPLE 3:

Marks must be awarded **positively**:

- marks are awarded for correct/valid answers, as defined in the mark scheme. However, credit is given for valid answers which go beyond the scope of the syllabus and mark scheme, referring to your Team Leader as appropriate
- marks are awarded when candidates clearly demonstrate what they know and can do
- marks are not deducted for errors
- marks are not deducted for omissions
- answers should only be judged on the quality of spelling, punctuation and grammar when these features are specifically assessed by the question as indicated by the mark scheme. The meaning, however, should be unambiguous.

GENERIC MARKING PRINCIPLE 4:

Rules must be applied consistently e.g. in situations where candidates have not followed instructions or in the application of generic level descriptors.

GENERIC MARKING PRINCIPLE 5:

Marks should be awarded using the full range of marks defined in the mark scheme for the question (however; the use of the full mark range may be limited according to the quality of the candidate responses seen).

GENERIC MARKING PRINCIPLE 6:

Marks awarded are based solely on the requirements as defined in the mark scheme. Marks should not be awarded with grade thresholds or grade descriptors in mind.

Question	Answer	Marks												
1(a)(i)	<table border="1"> <thead> <tr> <th>peak</th> <th>organic compound</th> <th>explanation</th> </tr> </thead> <tbody> <tr> <td>J</td> <td>carboxylic acid</td> <td>most polar</td> </tr> <tr> <td>K</td> <td>ketone</td> <td>polarity between J and L</td> </tr> <tr> <td>L</td> <td>alkene</td> <td>most non-polar</td> </tr> </tbody> </table> <p>peak assignments [1] explanation of J or L [1]</p>	peak	organic compound	explanation	J	carboxylic acid	most polar	K	ketone	polarity between J and L	L	alkene	most non-polar	2
peak	organic compound	explanation												
J	carboxylic acid	most polar												
K	ketone	polarity between J and L												
L	alkene	most non-polar												
1(a)(ii)	% of K = $18/92 = 19.6\%$	1												
1(b)(i)	$Cl_2 + AlCl_3 \rightarrow Cl^+ + AlCl_4^-$	1												
1(b)(ii)	<p>[1]</p> <p>intermediate [1] curly arrow [1]</p> <p>[1]</p>	4												
1(b)(iii)	$H^+ + AlCl_4^- \rightarrow AlCl_3 + HCl$	1												
1(c)(i)	catalyst and the reactants are in the same phase / state	1												
1(c)(ii)	(Rh) heterogeneous AND (Fe ³⁺) homogeneous	1												

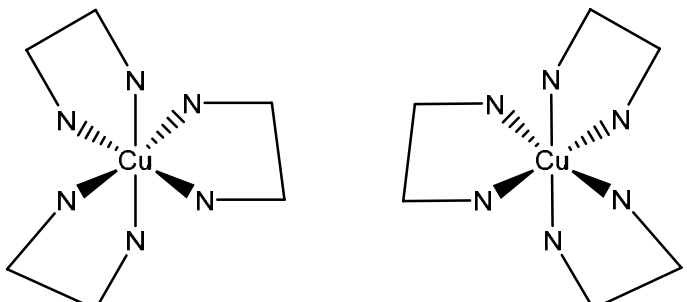
Question	Answer	Marks												
2(a)	<div style="display: flex; justify-content: space-around; align-items: center;"> <div style="text-align: center;"> <p>3d</p> <p>Cu [Ar] <table border="1" style="display: inline-table; border-collapse: collapse;"><tr><td>↑</td><td>↑</td><td>↑</td><td>↑</td><td>↑</td></tr></table></p> <p>Cu²⁺ [Ar] <table border="1" style="display: inline-table; border-collapse: collapse;"><tr><td>↑</td><td>↑</td><td>↑</td><td>↑</td><td>↑</td></tr></table></p> </div> <div style="text-align: center;"> <p>4s</p> <p><table border="1" style="display: inline-table; border-collapse: collapse;"><tr><td>↑</td></tr></table></p> <p><table border="1" style="display: inline-table; border-collapse: collapse;"><tr><td> </td></tr></table></p> </div> </div> <p style="text-align: right;">[1] × 2</p>	↑	↑	↑	↑	↑	↑	↑	↑	↑	↑	↑		2
↑	↑	↑	↑	↑										
↑	↑	↑	↑	↑										
↑														
2(b)(i)	orbitals have the same energy	1												
2(b)(ii)	d-d splitting seen, leading to 2 upper and 3 lower orbitals	1												
2(c)	an ion / molecule that donates two pairs of electrons	1												
2(d)	 <p>one correct [1] two correct and mirror images of each other [1]</p>	2												

Question	Answer	Marks
3(a)(i)	solution of A $[\text{Co}(\text{NH}_3)_6]^{2+}$ [1] precipitate B CoCO_3 [1]	2
3(a)(ii)	$\text{NaOH}(\text{aq}) / \text{OH}^-(\text{aq})$	1
3(a)(iii)	$[\text{Co}(\text{H}_2\text{O})_4(\text{OH})_2] + 6\text{NH}_3 \rightarrow [\text{Co}(\text{NH}_3)_6]^{2+} + 4\text{H}_2\text{O} + 2\text{OH}^-$	1

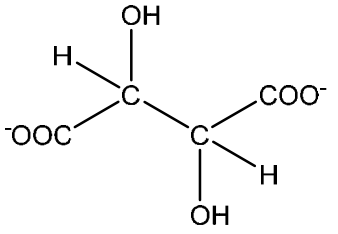
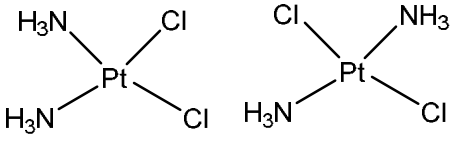
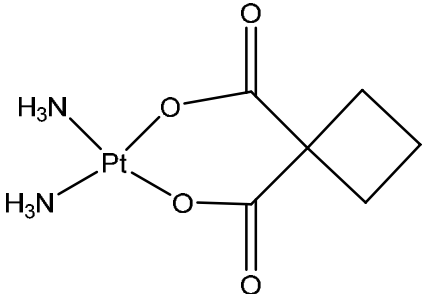
Question	Answer	Marks
3(a)(iv)	$[\text{Co}(\text{H}_2\text{O})_6]^{2+} + \text{CO}_3^{2-} \rightarrow \text{CoCO}_3 + 6\text{H}_2\text{O}$	1
3(b)(i)	variable oxidation states	1
3(b)(ii)		1
3(b)(iii)	$\text{C}_4\text{H}_4\text{O}_6^{2-} + 3[\text{O}] \rightarrow 2\text{HCO}_2^- + 2\text{CO}_2 + \text{H}_2\text{O}$	1
3(c)(i)	 <p style="text-align: center;">cis trans</p> <p>square planar shape of one isomer [1] both isomers drawn and assigned as cis and trans correctly [1]</p>	2
3(c)(ii)	this can react / bond / bind with <u>DNA</u> [1] which prevents replication of the strand / prevents cell division / prevents mitosis [1]	2
3(d)		1

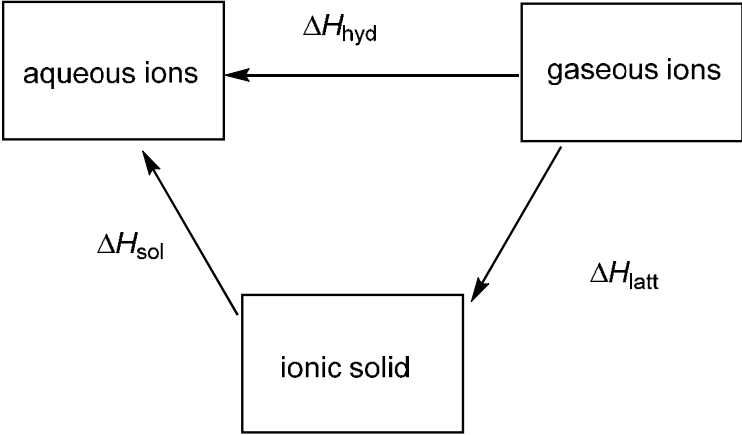
Question	Answer	Marks
4(a)	$\text{Ca}_3\text{N}_2 + 6\text{H}_2\text{O} \rightarrow 3\text{Ca}(\text{OH})_2 + 2\text{NH}_3$ products are $\text{Ca}(\text{OH})_2$ and NH_3 [1] rest of the equation, balanced [1]	2
4(b)	M1: solubility increases (down the Group) [1] M2: because lattice energy and hydration energy decreases or lattice energy and hydration energy become less exothermic / (more) endothermic [1] M3: because lattice energy decreases to a greater extent (than does ΔH_{hyd}) [1]	3
4(c)	 <p>aqueous ions</p> <p>gaseous ions</p> <p>ionic solid</p> <p>ΔH_{hyd}</p> <p>ΔH_{sol}</p> <p>ΔH_{latt}</p> <p>arrow label and direction correct [1] x 3</p>	3
4(d)(i)	$K_{\text{sp}} = [\text{Ca}^{2+}][\text{F}^-]^2$ [1] units = $\text{mol}^3 \text{dm}^{-9}$ [1]	2
4(d)(ii)	$K_{\text{sp}} = 4x^3 = 3.45 \times 10^{-11}$ $x = 2.05 \times 10^{-4} \text{ (mol dm}^{-3}\text{)}$	1

Question	Answer	Marks
5(a)	ionic radius / ion size increases OR charge density decreases (down the group) [1] less polarisation / distortion of anion / nitrate ion / NO_3^- / nitrate group OR N-O / N=O bond is less weakened / distorted / polarised OR more energy to break N-O / N=O bond [1]	2
5(b)	<ul style="list-style-type: none"> moles of Ce^{4+} = $0.0400 \times 21.8 / 1000 = 8.72 \times 10^{-4}$ (moles of Ce^{4+}) moles of NO_2^- = $8.72 \times 10^{-4} / 2 = 4.36 \times 10^{-4}$ in 25 cm^3 (use of 2:1 ratio correctly) moles of NO_2^- = $4.36 \times 10^{-4} \times 4 = 1.74(4) \times 10^{-3}$ in 100 cm^3 (use of 4:1 ratio correctly) mass NaNO_2 = $1.74(4) \times 10^{-3} \times (23.0 + 14.0 + 32.0) = 0.120 \text{ g}$ (use of M_r correctly) % purity = $0.120 / 0.138 = 86.96\%$ (use of 0.0138 correctly) two points = [1] four points = [2] all five points = [3]	3
5(c)(i)	$5\text{NO}_2^- + 2\text{MnO}_4^- + 6\text{H}^+ \rightarrow 2\text{Mn}^{2+} + 5\text{NO}_3^- + 3\text{H}_2\text{O}$ OR $5\text{HNO}_2 + 2\text{MnO}_4^- + \text{H}^+ \rightarrow 2\text{Mn}^{2+} + 5\text{NO}_3^- + 3\text{H}_2\text{O}$ all species correct [1] balanced [1]	2
5(c)(ii)	$E^\circ_{\text{cell}} = 1.52 - 0.94 = \mathbf{0.58}$ (V)	1
5(d)(i)	weak acid is partly ionised and strong acid is completely ionised	1
5(d)(ii)	$K_a = \frac{[\text{H}^+][\text{NO}_2^-]}{[\text{HNO}_2]}$	1
5(d)(iii)	$K_a = [\text{H}^+]^2 / [\text{HNO}_2]$ $[\text{H}^+] = \sqrt{0.00069 \times 0.15} = 1.02 \times 10^{-2}$ [1] $\text{pH} = -\log[\text{H}^+] = \mathbf{2.0 (1.99)}$ [1] minimum 2 significant figures	2
5(d)(iv)	% ionisation = $100 \times 1.02 \times 10^{-2} / 0.15 = \mathbf{6.7-6.8\%}$	1

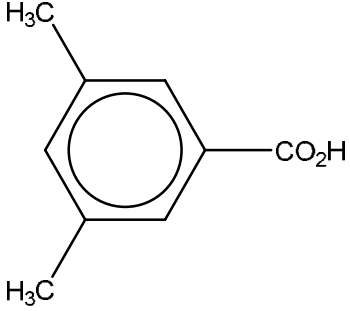
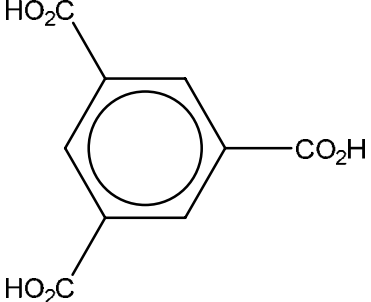
Question	Answer	Marks						
5(e)(i)	M1 A solution that resists changes in pH [1] M2 when small amounts of acid or alkali are added to it [1]	2						
5(e)(ii)	M1 $\text{HNO}_2 + \text{OH}^- \rightarrow \text{NO}_2^- + \text{H}_2\text{O}$ [1] M2 $\text{NO}_2^- + \text{H}^+ \rightarrow \text{HNO}_2$ [1]	2						
5(f)(i)	CuCN / copper(I) cyanide	1						
5(f)(ii)	<div style="display: flex; justify-content: space-around; align-items: center;"> <div style="text-align: center;">  <p>Y</p> </div> <div style="text-align: center;">  <p>Z</p> </div> </div> <p style="text-align: right;">[1] × 2</p>	2						
5(g)	<table border="1" style="margin-left: auto; margin-right: auto;"> <thead> <tr> <th></th> <th>number of peaks</th> </tr> </thead> <tbody> <tr> <td>W</td> <td>6</td> </tr> <tr> <td>Z</td> <td>3</td> </tr> </tbody> </table> <p style="text-align: right;">[1] × 2</p>		number of peaks	W	6	Z	3	2
	number of peaks							
W	6							
Z	3							

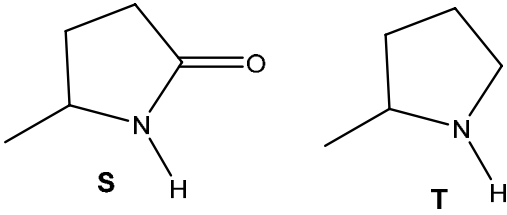
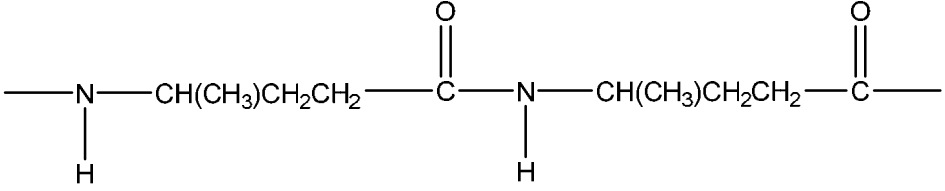
Question	Answer	Marks
6(a)(i)	KCN / NaCN / CN ⁻	1
6(a)(ii)	step 1 PCl_3 + heat / PCl_5 / $SOCl_2$ [1] step 4 $NaBH_4$ [1]	2
6(b)(i)		2
6(b)(ii)	step I condensation [1] step II reduction [1]	2
6(c)	 <ul style="list-style-type: none"> • amide bond (CO-NH) • structure of polymer with exactly two repeat units • continuation bonds • hydrocarbon portions correct <p>two points = [1] four points = [1]</p>	2

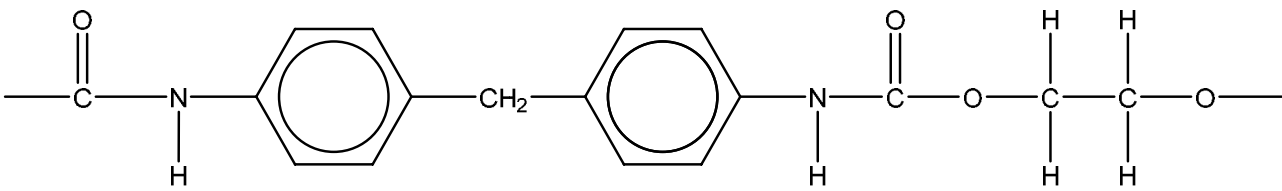
Question	Answer	Marks										
7(a)(i)	$C_{15}H_{10}N_2O_2$	1										
7(a)(ii)	 <p>-NH-CO-O- linkage [1] whole molecule correct [1]</p>	2										
7(a)(iii)	<table border="1" data-bbox="571 534 1702 766"> <thead> <tr> <th data-bbox="571 534 1097 598">intermolecular force</th> <th data-bbox="1097 534 1702 598">group(s) involved</th> </tr> </thead> <tbody> <tr> <td data-bbox="571 598 1097 662">hydrogen bonding</td> <td data-bbox="1097 598 1702 662">NH</td> </tr> <tr> <td data-bbox="571 662 1097 766">VDW forces / Induced dipole-dipole forces / polar forces</td> <td data-bbox="1097 662 1702 766">-C₆H₄CH₂- allow benzene / aromatic rings</td> </tr> </tbody> </table> <p>M1 hydrogen bonding [1] M2 NH group for hydrogen AND second correct IMF [1]</p>	intermolecular force	group(s) involved	hydrogen bonding	NH	VDW forces / Induced dipole-dipole forces / polar forces	-C ₆ H ₄ CH ₂ - allow benzene / aromatic rings	2				
intermolecular force	group(s) involved											
hydrogen bonding	NH											
VDW forces / Induced dipole-dipole forces / polar forces	-C ₆ H ₄ CH ₂ - allow benzene / aromatic rings											
7(b)	<table border="1" data-bbox="571 901 1702 1228"> <thead> <tr> <th data-bbox="571 901 1097 965">type of polymer</th> <th data-bbox="1097 901 1702 965">example</th> </tr> </thead> <tbody> <tr> <td data-bbox="571 965 1097 1029">synthetic polyamide</td> <td data-bbox="1097 965 1702 1029">nylon / Kevlar</td> </tr> <tr> <td data-bbox="571 1029 1097 1093">synthetic polyester</td> <td data-bbox="1097 1029 1702 1093">Terylene</td> </tr> <tr> <td data-bbox="571 1093 1097 1157">conducting polymer</td> <td data-bbox="1097 1093 1702 1157">polyacetylene / polyethyne</td> </tr> <tr> <td data-bbox="571 1157 1097 1228">non-solvent based adhesive</td> <td data-bbox="1097 1157 1702 1228">epoxyresins / superglue</td> </tr> </tbody> </table> <p>one mark [1] for each correct answer up to a maximum of [3]</p>	type of polymer	example	synthetic polyamide	nylon / Kevlar	synthetic polyester	Terylene	conducting polymer	polyacetylene / polyethyne	non-solvent based adhesive	epoxyresins / superglue	3
type of polymer	example											
synthetic polyamide	nylon / Kevlar											
synthetic polyester	Terylene											
conducting polymer	polyacetylene / polyethyne											
non-solvent based adhesive	epoxyresins / superglue											

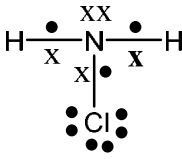
Question	Answer	Marks
8(a)(i)	species with an unpaired electron	1
8(a)(ii)	$\text{NH}_2 + \text{Cl} \rightarrow \text{NH}_2\text{Cl}$	1
8(b)(i)		1
8(b)(ii)	sp^3 AND $100\text{--}107^\circ$	1
8(c)(i)	(entropy) is a measure of the disorder/randomness of a system	1
8(c)(ii)	$\Delta S^\circ = 237 + 187 - (241 + 198) = -15.0 \text{ (J K}^{-1} \text{ mol}^{-1}\text{)}$	1
8(c)(iii)	$\Delta H^\circ = 95.4 - 92.3 - (80.1 - 45.9) = -31.1 \text{ (kJ mol}^{-1}\text{)}$	1
8(c)(iv)	$\Delta G^\circ = \Delta H^\circ - T\Delta S^\circ$ [1] $\Delta G^\circ = -31.1 - (298 \times -0.015) = -26.6 \text{ (kJ mol}^{-1}\text{)}$ [1]	2
8(c)(v)	(at higher temperatures) $T\Delta S^\circ$ becomes more negative so ΔG° becomes more positive OR (at high temperatures) $-T\Delta S^\circ$ is becomes more positive so ΔG° becomes more positive	1
8(d)	ethylamine > ammonia > phenylamine [1] ethyl group is electron donating group [1] p-orbital from N in phenylamine overlaps with π -ring system OR lone pair on N is delocalised into benzene ring [1] basicity linked to ability of N to accept a proton [1]	4

PUBLISHED

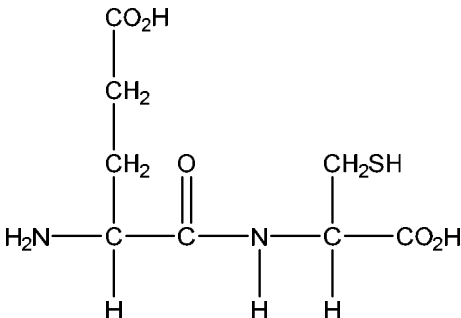
Question	Answer	Marks								
9(a)	<div style="text-align: center;">  </div> <p>M1 peptide link [1] M2 rest of the structure [1]</p>	2								
9(b)	<table border="1" data-bbox="882 639 1393 903" style="margin-left: auto; margin-right: auto;"> <thead> <tr> <th>spot</th> <th>identity</th> </tr> </thead> <tbody> <tr> <td style="text-align: center;">E</td> <td style="text-align: center;">Glu</td> </tr> <tr> <td style="text-align: center;">F</td> <td style="text-align: center;">Glu-Cys</td> </tr> <tr> <td style="text-align: center;">G</td> <td style="text-align: center;">Cys</td> </tr> </tbody> </table> <p>M1 correct table [1] M2 Explanation of why Cys moves the least – because it exists as a zwitterion / it is almost neutral [1] M3 Explanation of why Glu-Cys moves a smaller distance than Glu – a comparative statement that Glu-Cys has a greater M_r than Glu [1]</p>	spot	identity	E	Glu	F	Glu-Cys	G	Cys	3
spot	identity									
E	Glu									
F	Glu-Cys									
G	Cys									