

CANDIDATE
NAME

--

CENTRE
NUMBER

--	--	--	--	--

CANDIDATE
NUMBER

--	--	--	--



COMPUTER SCIENCE

9608/11

Paper 1 Theory Fundamentals

October/November 2015

1 hour 30 minutes

Candidates answer on the Question Paper.

No Additional Materials are required.

No calculators allowed.

READ THESE INSTRUCTIONS FIRST

Write your Centre number, candidate number and name in the spaces at the top of this page.

Write in dark blue or black pen.

You may use an HB pencil for any diagrams, graphs or rough working.

Do not use staples, paper clips, glue or correction fluid.

DO NOT WRITE IN ANY BARCODES.

Answer **all** questions.

No marks will be awarded for using brand names of software packages or hardware.

At the end of the examination, fasten all your work securely together.

The number of marks is given in brackets [] at the end of each question or part question.

The maximum number of marks is 75.

This document consists of **12** printed pages.

1 (a) Explain the term bit streaming.

.....
.....
.....
..... [2]

(b) A person watches a film streamed from a website on a tablet computer.

(i) Give **two** benefits of using bit streaming for this purpose.

1
.....
2
..... [2]

(ii) State **two** potential problems of using bit streaming for this purpose.

1
.....
2
..... [2]

(c) Explain the terms on-demand bit streaming and real-time bit streaming.

.....
.....
.....
.....
.....
.....
.....
.....
.....
.....
..... [4]

2 (a)

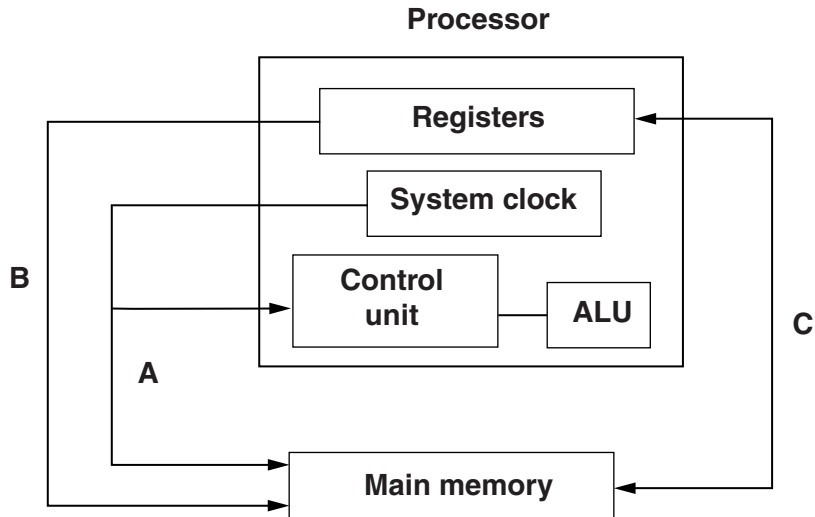

The diagram above shows a simplified form of processor architecture.

Name the three buses labelled A, B and C.

A

B

C

[3]

(b) State the role of each of the following special purpose registers used in a typical processor.

Program Counter

.....

Memory Data Register

.....

Current Instruction Register

.....

Memory Address Register

.....

[4]

3 (a) The table shows four statements about IP addresses.

Tick (✓) to show which of the statements are true.

Statement	True (✓)
The IP address consists of any number of digits separated by single dots (.)	
Each number in an IP address can range from 0 to 255	
IP addresses are used to ensure that messages and data reach their correct destinations	
Public IP addresses are considered to be more secure than private IP addresses	

[2]

(b) Consider the URL:

<http://cie.org.uk/computerscience.html>

(i) Give the meaning of the following parts of the URL.

http

.....

.....

cie.org.uk

.....

.....

computerscience.html

.....

.....

[3]

(ii) Sometimes the URL contains the characters %20 and ?.

Describe the function of these characters.

%20

.....

?

.....

[2]

- 4 Paul works part-time for a large software company. The company sells security software to a number of banks. He also runs his own software company that produces and sells computer games.

Six statements about computer ethics are shown below.

Draw lines to indicate whether each statement describes ethical or unethical behaviour.

Statement

To save time, Paul fakes the test results when testing the bank security software.

Paul uses the software developed in his day job to help write some of the games software routines.

To allow him to concentrate on his games software, Paul has frequently turned down job opportunities in his day job.

To make the games software more realistic, Paul uses password protection code used in the bank security software.

Because his work load is increasing, Paul is now using overseas companies to write some of the routines used in his games software.

Paul carries out training on how to write games software in his spare time.

Ethical

Unethical

[6]

5 A computer system in a control room is used to monitor earthquake activity.

An earthquake zone has a number of sensors to detect seismic activity.

The system detects when seismic activity is greater than 3 on the Richter Scale. Whenever this happens, a printer in the control room prints a report.

(i) Identify the steps that are required in this monitoring system.

.....
.....
.....
.....
.....
.....
.....
.....[4]

(ii) When the system detects high activity, operators may need to respond rapidly. A printer is useful for hard copies, but may not be the best way to inform operators.

Give a reason why.
.....
.....[1]

(iii) Name an alternative output device for this monitoring system and give a reason for your choice.

Output device
Reason for choice
.....
.....[2]

- 6 A company operates a chemical plant, which has a number of processes. Local computers monitor these processes and collect data.

The computers transfer these data to a central computer 50km away. A telecommunications company (telco) provides cables.

Engineers at the telco had to decide which type of cable to use. They considered the use of either copper cable or fibre optic cable.

State **two** benefits of each type of cable. Each benefit must be clearly different.

Benefits of copper cable

1

2

Benefits of fibre optic cable

1

2

[4]

7 (a) (i) Describe what is meant by a client-server model of networked computers.

.....
.....
.....
.....[2]

(ii) Give **two** benefits of using the client-server model.

1
.....
2
.....[2]

(b) The diagram shows a computer network with connection to the Internet.

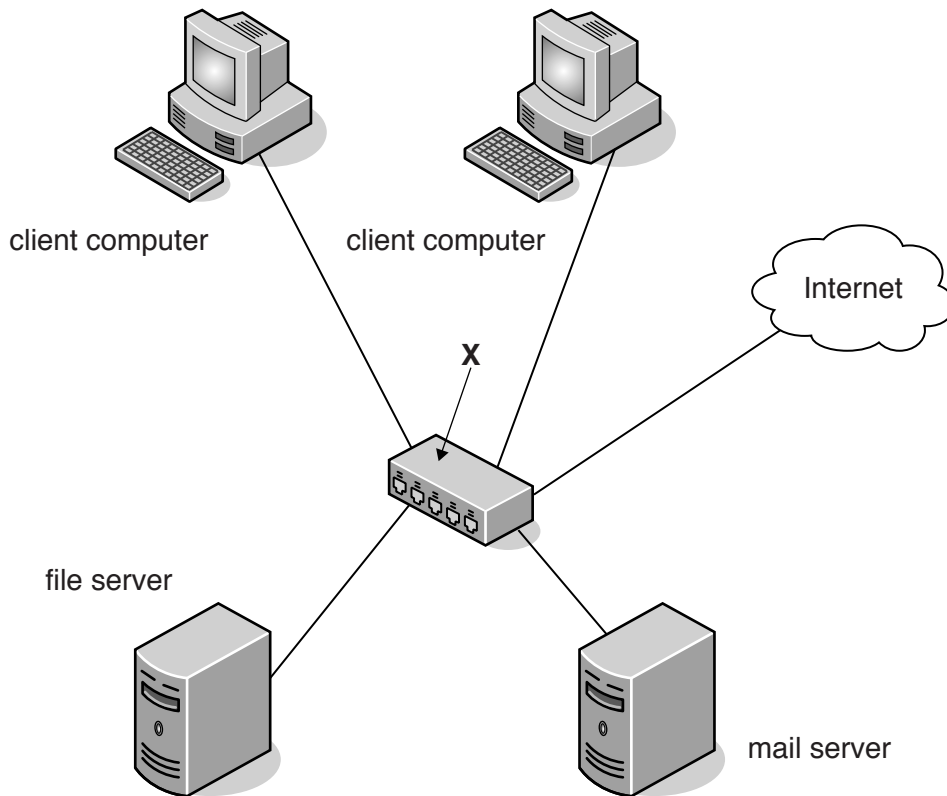

Name the hardware device labelled X.

.....[1]

- (c) A web page offers a link for users to request another web page. The requested web page contains HTML code and JavaScript code.

Put each statement in the correct sequence by writing the numbers 1 to 5 in the right-hand column.

Statement	Sequence number
The requested web page is displayed on the client computer	
The user clicks on the hyperlink and the web page is requested from the web server	
The requested web page content is transmitted to the client computer	
The client computer processes the JavaScript code using the web browser software	
The web server locates the requested web page	

[5]

- 8 (a) Six computer graphics terms and seven descriptions are shown below.

Draw a line to link each term to its correct description.

Term	Description
Bitmap graphic	Measured in dots per inch (dpi); this value determines the amount of detail an image has
Image file header	Picture element
Image resolution	Image made up of rows and columns of picture elements
Pixel	Image made up of drawing objects. The properties of each object determine its shape and appearance.
Screen resolution	Specifies the image size, number of colours, and other data needed to display the image data
Vector graphic	Number of samples taken per second to represent some event in a digital format
	Value quoted for a monitor specification, such as 1024 × 768. The larger the numbers, the more picture elements will be displayed.

[6]

(b) (i) A black and white image is 512 pixels by 256 pixels.

Calculate the file size of this image in kilobytes (KB) (1 KB = 1024 bytes).
Show your working.

.....
.....
.....
.....
.....[2]

(ii) Give a reason why it is important to estimate the file size of an image.

.....
.....
.....[1]

9 (a) Give a brief description of each of the following terms:

Validation
.....
.....

Verification
.....
.....[2]

(b) Data are to be transferred between two devices. Parity checks are carried out on the data.

Explain what is meant by a parity check. Give an example to illustrate your answer.

.....
.....
.....
.....
.....
.....
.....
.....
.....[4]

10 (a) Explain the term computer virus.

.....

.....

.....

..... [2]

(b) A virus checker has been installed on a PC.

Give **two** examples of when a virus checker should perform a check.

1

.....

2

..... [2]

11 A game program is written which can be either interpreted or compiled. The table below shows five statements about the use of interpreters and compilers.

Tick (✓) to show whether the statement refers to an interpreter or to a compiler.

Statement	Interpreter	Compiler
This translator creates an executable file		
When this translator encounters a syntax error, game execution halts		
The translator analyses and checks each line just before executing it		
This translator will produce faster execution of the game program		
Use of this translator makes it more difficult for the user to modify the code of the game		

[5]

Permission to reproduce items where third-party owned material protected by copyright is included has been sought and cleared where possible. Every reasonable effort has been made by the publisher (UCLES) to trace copyright holders, but if any items requiring clearance have unwittingly been included, the publisher will be pleased to make amends at the earliest possible opportunity.

To avoid the issue of disclosure of answer-related information to candidates, all copyright acknowledgements are reproduced online in the Cambridge International Examinations Copyright Acknowledgements Booklet. This is produced for each series of examinations and is freely available to download at www.cie.org.uk after the live examination series.

Cambridge International Examinations is part of the Cambridge Assessment Group. Cambridge Assessment is the brand name of University of Cambridge Local Examinations Syndicate (UCLES), which is itself a department of the University of Cambridge.