DESIGN AND TECHNOLOGY

9705/31

Paper 3

October/November 2014

3 hours

Additional Materials: Answer Booklet/Paper
 A range of design drawing equipment
 A3 Drawing Paper (5 sheets)



READ THESE INSTRUCTIONS FIRST

Write your Centre number, candidate number and name on all the work you hand in.
Write in dark blue or black pen.
You may use an HB pencil for any diagrams, graphs or rough working.
Do not use staples, paper clips, glue or correction fluid.
DO NOT WRITE IN ANY BARCODES.

Section A

Answer **two** questions from **one** of the Parts **A**, **B** or **C**.

Section B

Answer **one** question.

All dimensions are in millimetres.

The instruction 'discuss' denotes that you should:

- examine critically the issues raised by the question;
- explain and interpret these issues as appropriate;
- introduce evidence wherever possible to support conclusions of arguments.

At the end of the examination, fasten all your work securely together.

The number of marks is given in brackets [] at the end of each question or part question.

This document consists of **9** printed pages and **3** blank pages.

Section A

Answer **two** questions from one of the Parts **A, B** or **C**.

Part A – Product Design

- 1 Fig. 1 shows a garden bird feeder with details of the cover.

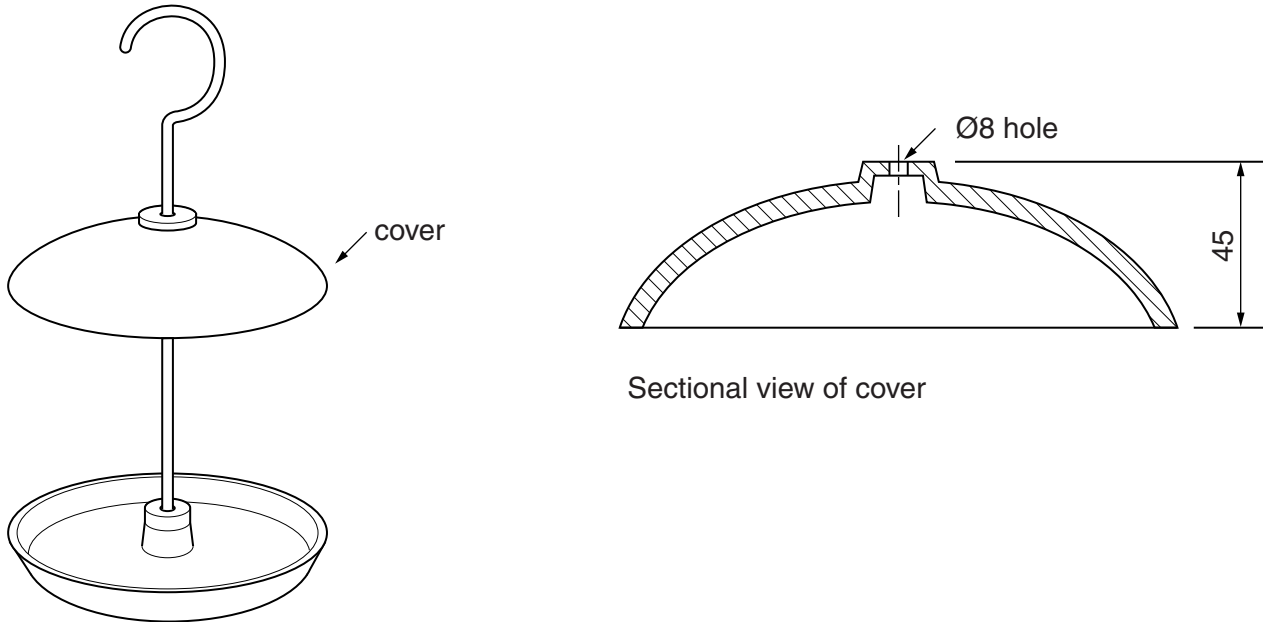

Fig. 1

- (a) State a suitable material for a cover of the type shown in Fig. 1 and give **two** reasons for your choice. [3]
- (b) Describe, using notes and sketches, how you would make the cover. [9]
- (c) Explain what changes may be necessary to the design, the manufacturing method used and the material selected, if 1000 covers were required. Use notes and sketches to support your answer. [8]

- 2 Frank Chimera, a designer, states “People ignore design that ignores people”.

Discuss the issues raised by this statement and the implications for product designers and those involved in the design industry. [20]

3

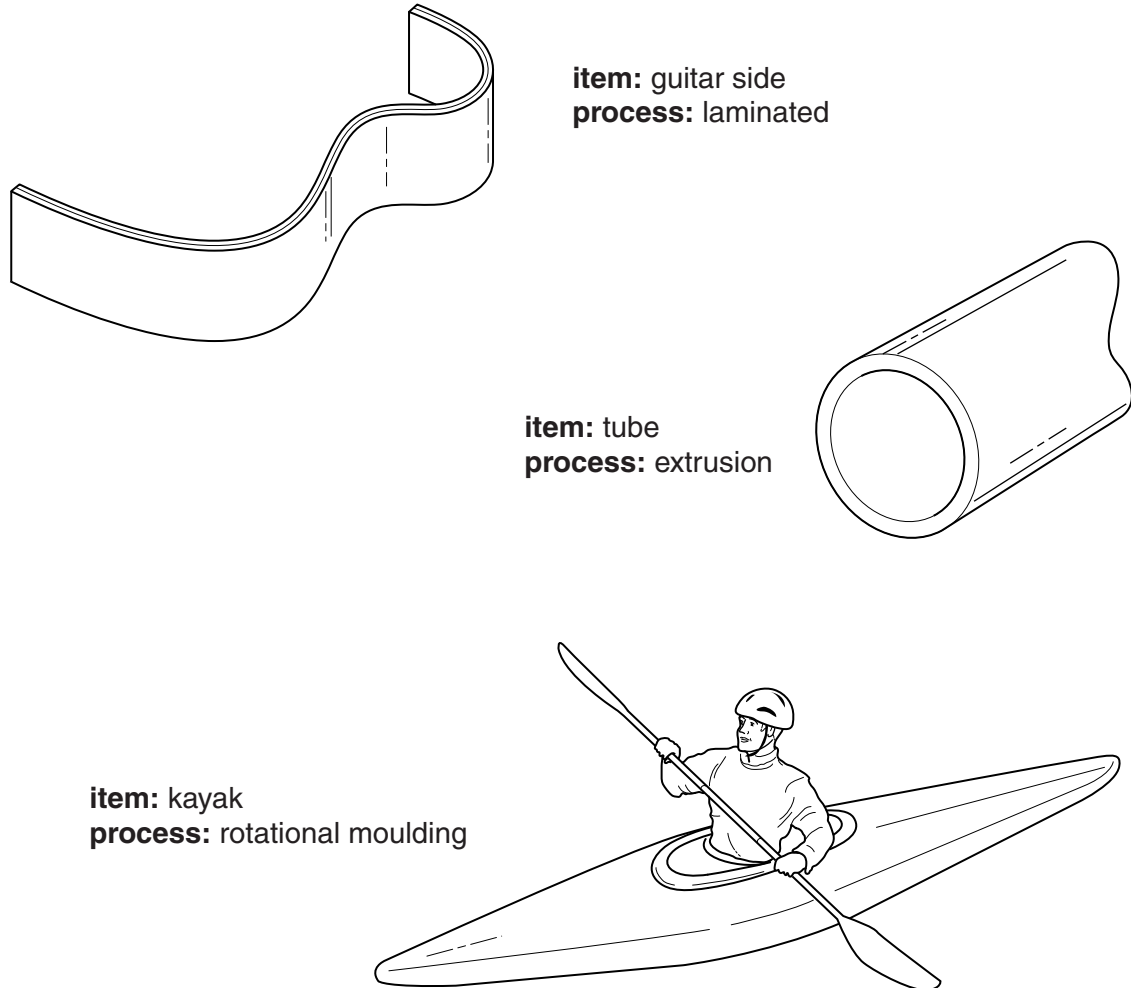

Fig. 2

Choose **two** of the items shown in Fig. 2 and for each:

- (a) use notes and sketches to describe the manufacture of the item using the process given; [7 × 2]
- (b) explain why the process is particularly suitable for the production of the item. [3 × 2]

Part B – Practical Technology

4 Name a specific product or component that makes use of the following properties. Explain why the properties are appropriate.

- Toughness
- Elasticity
- Thermal conductivity
- Corrosion resistance

Use a different product or component for each answer.

Include details of the function of the product and specific materials used where appropriate.

[4 × 5]

5 Fig. 3 shows details of a connecting link for a high speed engine.

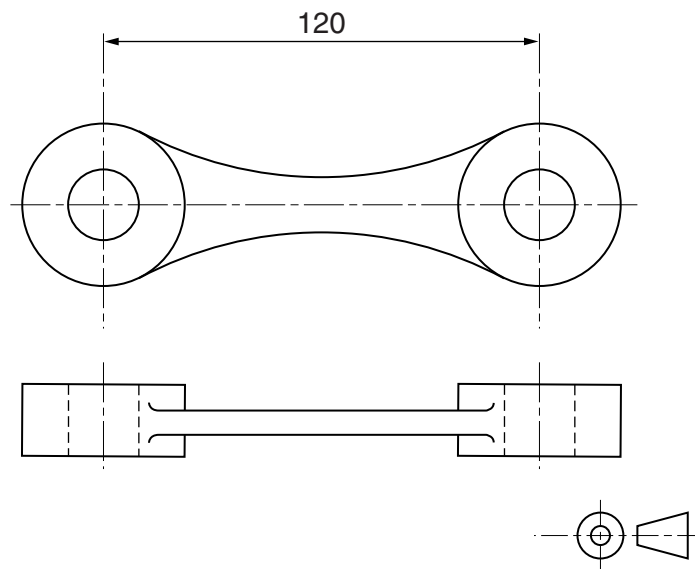

Fig. 3

The connecting link could be manufactured in the following methods:

- machined and welded;
- forged;
- pressed and stamped;
- die cast.

Select **two** of the methods listed above and compare and contrast their suitability for the manufacture of the connecting link.

Consider cost and time factors and include details of the manufacturing methods and specific materials used.

Use annotated sketches where appropriate to support your answer.

[20]

6 (a) Explain the working of the following components:

- photodiode;
- thermistor;
- relay.

[3 × 3]

(b) Fig. 4 shows a circuit for sensing moisture using a 741 Op-amp.

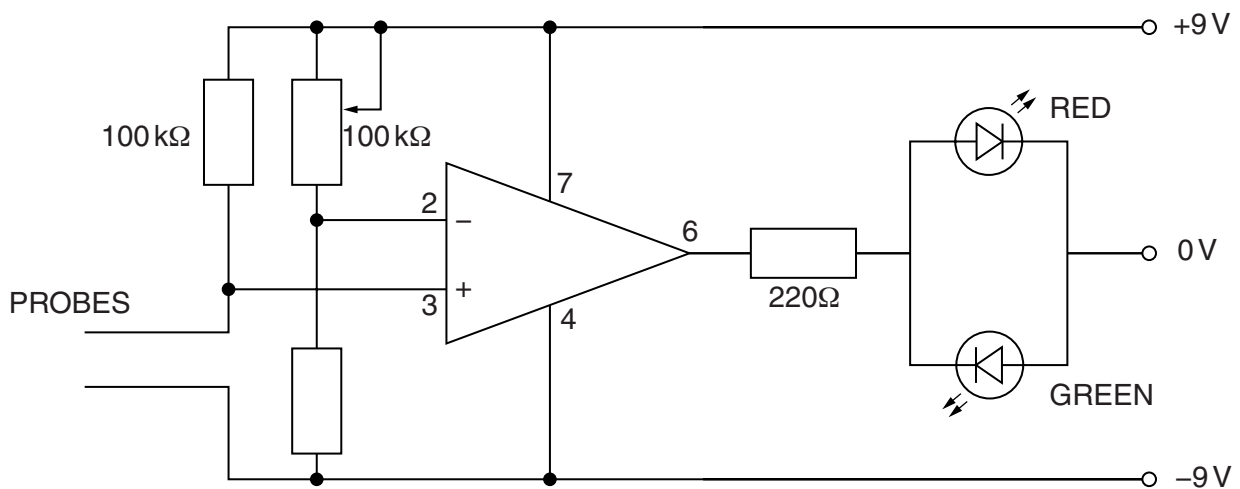

Fig. 4

(i) Explain how the circuit operates.

[5]

(ii) Make an annotated sketch of the casing for the circuit that would make it suitable for use by football and rugby referees to check if grass playing surfaces are too wet to play on safely.

[6]

Part C – Graphic Products

7 Discuss the importance of the use of 2D and 3D modelling to:

- architects;
- graphic designers;
- product designers.

[20]

8 Fig. 5 shows a development (net) for packaging to be used by a fast food outlet.

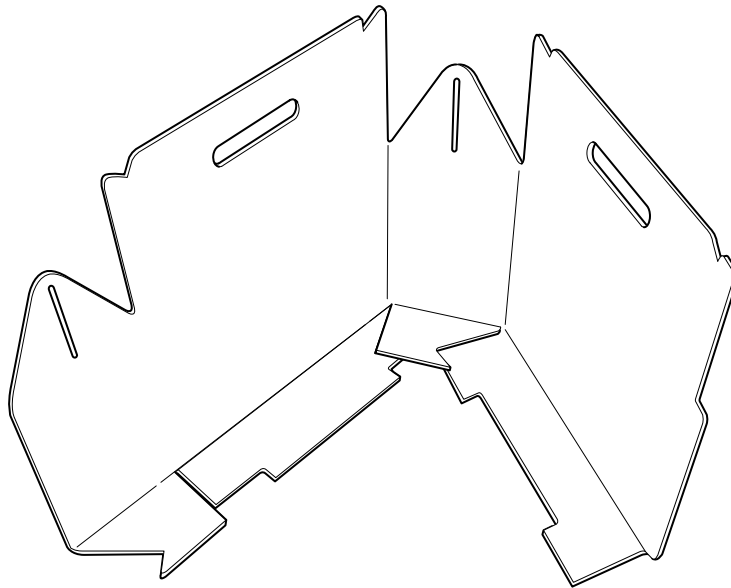

Fig. 5

- (a) The package will be printed on the outside, and will contain burgers, french fries and other food items.
State a specific suitable material for the packaging and give **two** reasons for your choice. [4]
- (b) Describe, using notes and sketches, how the packaging would be produced as a batch of 1000.
Include full details of the manufacturing and printing methods used. [16]

9 Fig. 6 shows details of a cast component.

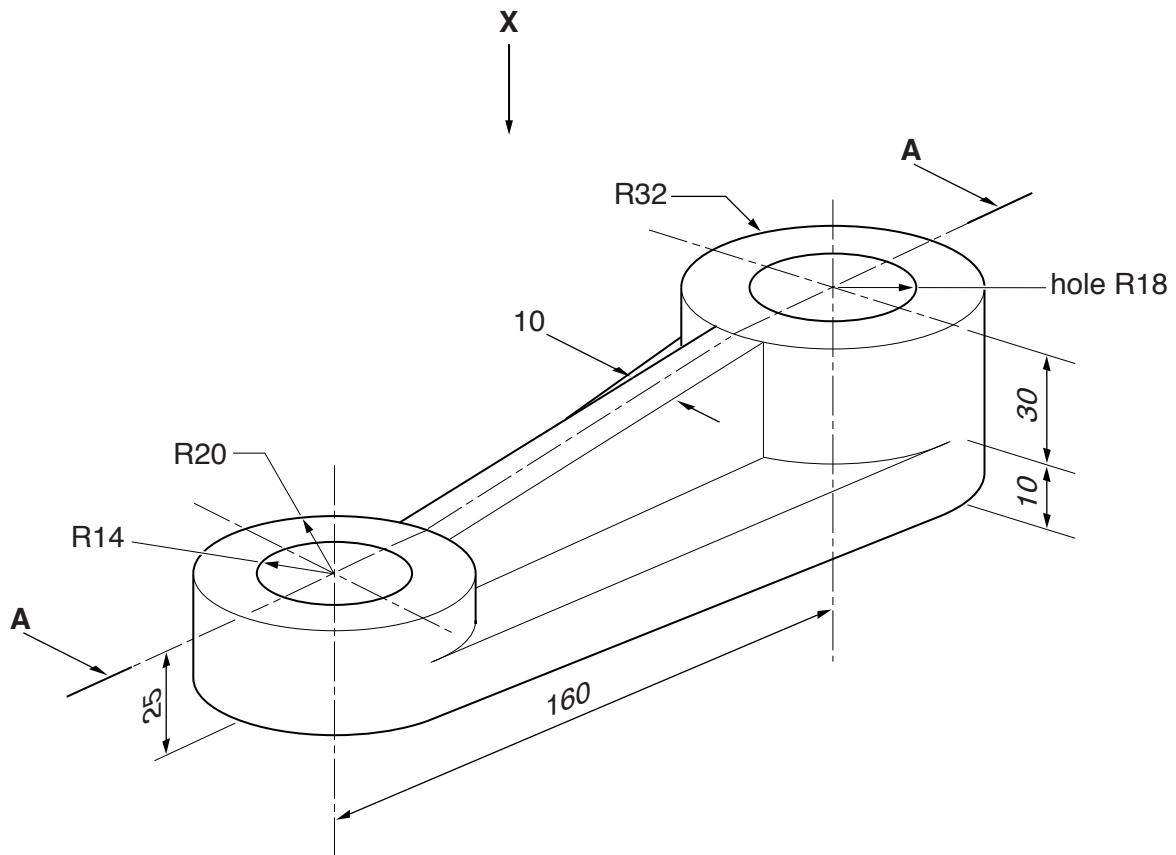

Fig. 6

- (a) Draw full size:
- a plan viewed from arrow **X**;
 - a sectional elevation on **AA**.

Fully dimension the drawing.

[14]

- (b) Explain the advantages of using a CAD (Computer Aided Design) system to draw components.

[6]

Section B

Answer **one** question on the A3 paper provided.

You should approach the design question of your choice in the following manner:

Analysis

Produce an analysis of the given situation/problem, which may be in written or graphical form. [5]

Specification

From the analysis produce a detailed written specification of the design requirements. Include at least five specification points other than those given in the question. [5]

Exploration

Use bold sketches and brief notes to show your exploration of ideas for a design solution, with reasons for selection. [25]

Development

Show using bold sketches and notes, the development, reasoning and composition of ideas into a single design proposal. Give details of materials, constructional and other relevant technical details. [25]

Proposed solution

Produce drawings of an appropriate kind to show the complete solution. [15]

Evaluation

Give a written evaluation of the final design solution. [5]

[Total: 80]

- 10** Cycling is an increasingly popular sport and pastime. Bicycles need regular servicing and maintenance to ensure that they are working effectively and that they are safe to use.

You are to design a product that will hold a bicycle securely whilst servicing and maintenance is being carried out.

The product must:

- be freestanding;
- take up minimum space for storage.

- 11** Many people, including the elderly and very young children, can be at risk during very cold weather.

You are to design a product that will clearly indicate that the temperature has fallen below a safe level in a room.

The product must:

- have an adjustable temperature setting;
- include an audible and visual alarm to indicate that the temperature has fallen below the set level.

- 12** Design a product to hold Graphics equipment to enable a student to work at school and at home.

The product must:

- hold up to 30 sheets of A3 paper;
- include secure storage space for basic Graphics equipment.

BLANK PAGE

Permission to reproduce items where third-party owned material protected by copyright is included has been sought and cleared where possible. Every reasonable effort has been made by the publisher (UCLES) to trace copyright holders, but if any items requiring clearance have unwittingly been included, the publisher will be pleased to make amends at the earliest possible opportunity.

Cambridge International Examinations is part of the Cambridge Assessment Group. Cambridge Assessment is the brand name of University of Cambridge Local Examinations Syndicate (UCLES), which is itself a department of the University of Cambridge.