

**DESIGN AND TECHNOLOGY**

**9705/31**

Paper 3

**October/November 2016**

**3 hours**

Additional Materials:      Answer Booklet/Paper  
   A range of design drawing equipment  
   A3 Drawing Paper (5 sheets)



**READ THESE INSTRUCTIONS FIRST**

Write your Centre number, candidate number and name on all the work you hand in.  
Write in dark blue or black pen.  
You may use an HB pencil for any diagrams, graphs or rough working.  
Do not use staples, paper clips, glue or correction fluid.  
**DO NOT WRITE IN ANY BARCODES.**

**Section A**

Answer any **two** questions from parts **A**, **B** or **C**.

**Section B**

Answer **one** question.

All dimensions are in millimetres.

The instruction 'discuss' denotes that you should:

- examine critically the issues raised by the question;
- explain and interpret these issues as appropriate;
- introduce evidence wherever possible to support conclusions of arguments.

At the end of the examination, fasten all your work securely together.

The number of marks is given in brackets [ ] at the end of each question or part question.

This document consists of **9** printed pages and **3** blank pages.

## Section A

Answer **two** questions from **one** of the Parts **A**, **B** or **C**.

## Part A – Product Design

1 Fig. 1 shows a clothing hook.

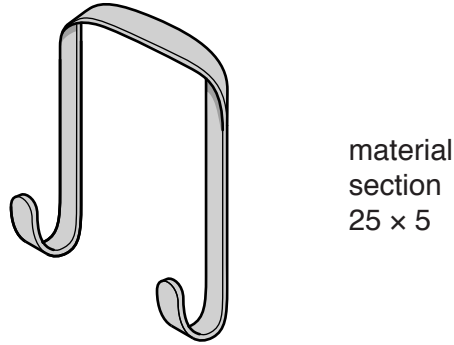
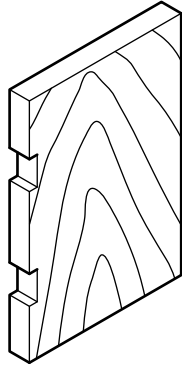
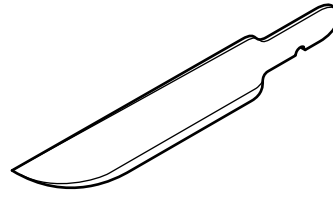

Fig. 1

- (a) State a suitable material for a clothing hook of the type shown in Fig. 1 and give **two** reasons for your choice. [3]
- (b) Describe, using notes and sketches, how you would make the clothing hook. [9]
- (c) Explain what changes may be necessary to the design, the manufacturing method used and the material selected, if 5000 clothing hooks were required. Use notes and sketches to support your answer. [8]
- 2 Discuss how aesthetic qualities, unit costs and available manufacturing processes influence a designer when selecting materials for **one** of the following:
- a mass produced pen
  - a one-off piece of furniture
  - a batch of 50 bathroom cabinets [20]

**item:** kitchen knife blade  
**process:** hardened and tempered



**item:** cabinet door  
**process:** edged and veneered

**item:** bath  
**process:** vacuum formed

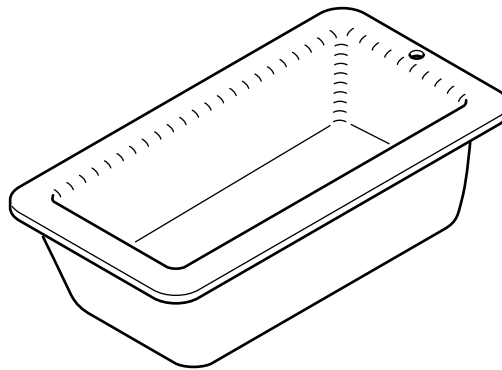

**Fig. 2**

Choose **two** of the items shown in Fig. 2 and for each:

- (a) use notes and sketches to describe how the process has been used in the manufacture of the item; [7 × 2]
- (b) explain why the process is particularly suitable in the production of the item. [3 × 2]

## Part B – Practical Technology

- 4 Adhesives and solvents are often used in the manufacture of products.
- (a) Identify **two** different adhesives or solvents and for each, state a specific application. [2]
  - (b) Describe, in detail, the process of using each of the adhesives or solvents identified in part (a). Include details of preparation, application and health and safety issues where appropriate. [12]
  - (c) Explain why adhesives or solvents are often used in preference to mechanical fixings. [6]
- 5 (a) Alloys are used in the manufacture of many products.
- (i) Name **two** alloys and state the specific materials used in each alloy. [6]
  - (ii) Identify **one** product for each of the alloys given in part (i). [2]
  - (iii) Explain why alloys are important in the design and manufacture of products. [4]
- (b) (i) Identify a product that requires the property of hardness and explain why this property is particularly suitable for the product identified. [3]
- (ii) Use notes and sketches to describe a simple test to measure the hardness of a material. [5]
- 6 Discuss how the following are considered in the design of a bicycle for an adult.
- Materials
  - Mechanisms
  - Friction
- [20]

## Part C – Graphic Products

7 Fig. 3 shows incomplete orthographic elevations of a decoration made from card.

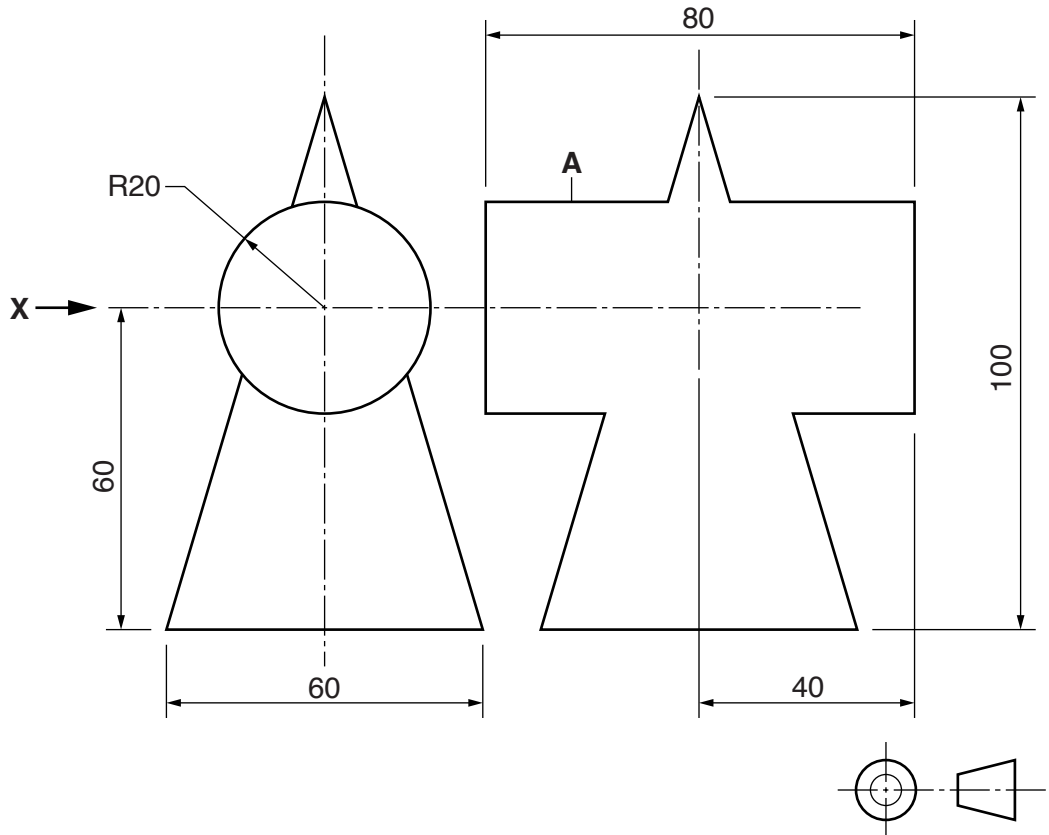

Fig. 3

- (a) (i) Complete a full size elevation seen from arrow X. [7]
- (ii) Draw a development (net) of the cylinder A. [7]
- (b) Explain the importance of using standardized drawing conventions. [6]
- 8 The Graphics department in a school has been asked to help design and produce materials for an open-evening to display the work of students in the school.
- (a) Describe **two** advantages of using CAD in the production of graphic images. [4]
- (b) Use notes and sketches to describe the process of printing:
- (i) a batch of 500, monochrome, 8 page, A4 size programmes for the open-evening event; [8]
- (ii) a batch of 8, A2 size posters to advertise the open-evening. The posters would have a maximum of 4 colours. [8]

- 9 Designers use a wide range of techniques to record and manipulate information and to communicate their ideas effectively.

Use notes and sketches to explain the following and give an appropriate example for each.

- Pictograms
- Bar charts
- Pie charts
- Ideograms

[20]

**Section B**

Answer **one** question on the A3 paper provided.

You should approach the design question of your choice in the following manner:

Analysis

Produce an analysis of the given situation/problem, which may be in written or graphical form. [5]

Specification

From the analysis produce a detailed written specification of the design requirements. Include at least five specification points other than those given in the question. [5]

Exploration

Use bold sketches and brief notes to show your exploration of ideas for a design solution, with reasons for selection. [25]

Development

Show using bold sketches and notes, the development, reasoning and composition of ideas into a single design proposal. Give details of materials, constructional and other relevant technical details. [25]

Proposed solution

Produce drawings of an appropriate kind to show the complete solution. [15]

Evaluation

Give a written evaluation of the final design solution. [5]

Total: [80]

- 10** Many families enjoy camping holidays. When camping in remote areas, personal washing facilities may be limited.

You are to design a portable washing facility that could be used on a camping holiday.

The product must be:

- easy to assemble;
- able to be used by children and adults.

- 11** Many schools support charities through fundraising events or collecting donations.

You are to design a collection box to be situated at the entrance of the school that will enable staff, students and visitors to donate coins.

The collection box must:

- give an electronic and/or mechanical response when a coin is donated;
- securely contain donations which are collected at the end of each school day.



- 12 A Hotel chain, Sunrise Hotels, is to provide a range of bathroom cosmetic products. They wish to supply shampoo, conditioner and body wash in 3 similarly shaped containers.

Design the packaging which will hold and display the 3 containers.

The packaging must clearly display the containers and allow customers to remove and replace them after use.

Design the labels for each of the containers to identify the contents.

The labels must reflect the image of the Sunrise Hotels chain.

Details of the containers are given in Fig. 4.

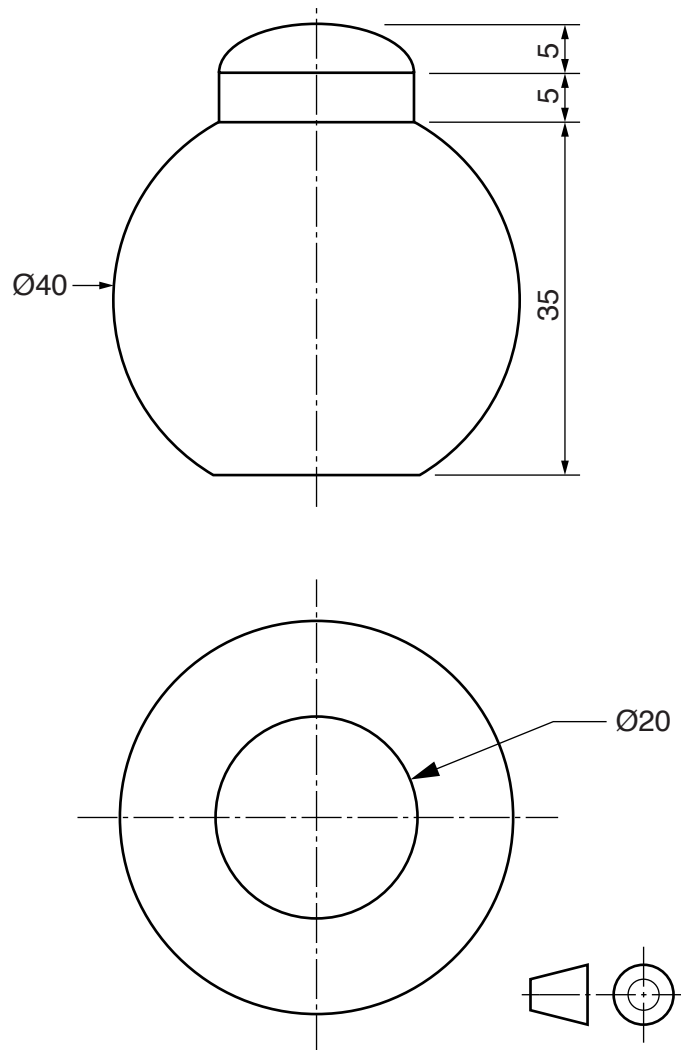

Fig. 4





**BLANK PAGE**

---

Permission to reproduce items where third-party owned material protected by copyright is included has been sought and cleared where possible. Every reasonable effort has been made by the publisher (UCLES) to trace copyright holders, but if any items requiring clearance have unwittingly been included, the publisher will be pleased to make amends at the earliest possible opportunity.

To avoid the issue of disclosure of answer-related information to candidates, all copyright acknowledgements are reproduced online in the Cambridge International Examinations Copyright Acknowledgements Booklet. This is produced for each series of examinations and is freely available to download at [www.cie.org.uk](http://www.cie.org.uk) after the live examination series.

Cambridge International Examinations is part of the Cambridge Assessment Group. Cambridge Assessment is the brand name of University of Cambridge Local Examinations Syndicate (UCLES), which is itself a department of the University of Cambridge.