



UNIVERSITY OF CAMBRIDGE INTERNATIONAL EXAMINATIONS
International General Certificate of Secondary Education

CANDIDATE
NAME

CENTRE
NUMBER

--	--	--	--	--

CANDIDATE
NUMBER

--	--	--	--



PHYSICS

0625/62

Paper 6 Alternative to Practical

May/June 2012

1 hour

Candidates answer on the Question Paper.

No Additional Materials are required.

READ THESE INSTRUCTIONS FIRST

Write your Centre number, candidate number and name on all the work you hand in.
Write in dark blue or black pen.
You may use a pencil for any diagrams, graphs or rough working.
Do not use staples, paper clips, highlighters, glue or correction fluid.
DO NOT WRITE IN ANY BARCODES.

Answer **all** questions.

At the end of the examination, fasten all your work securely together.
The number of marks is given in brackets [] at the end of each question or part question.

For Examiner's Use	
1	
2	
3	
4	
5	
Total	

This document consists of **11** printed pages and **1** blank page.



- 1 The IGCSE class is investigating the effect of a load on a metre rule attached to a force

The apparatus is shown in Fig. 1.1.

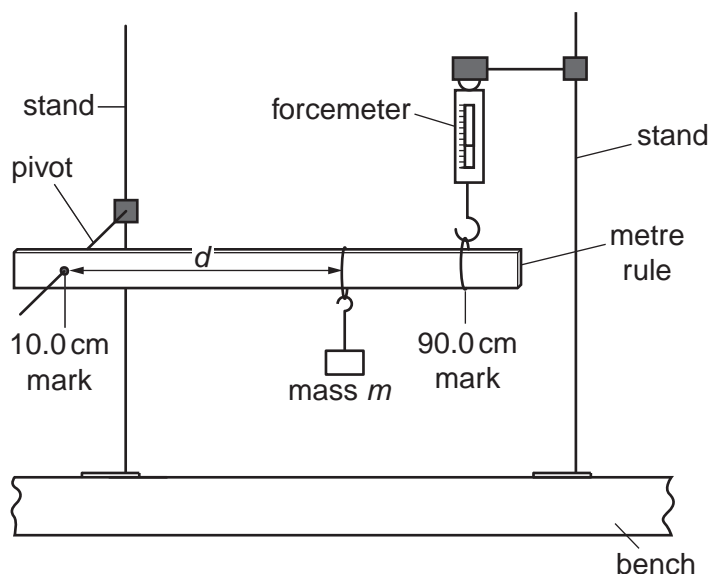

Fig. 1.1

The rule is pivoted near one end at the 10.0 cm mark. Near the other end, at the 90.0 cm mark, the rule is attached to a forcemeter. A mass is hanging from the rule at a distance d from the pivot.

- (a) A student moves the mass to a distance $d = 70.0$ cm from the pivot. He adjusts the height of the forcemeter until the rule is again horizontal. He records the reading F on the forcemeter.

He repeats the procedure using d values of 60.0 cm, 50.0 cm, 40.0 cm, 30.0 cm, 20.0 cm and 10.0 cm. The forcemeter readings are shown in Table 1.1.

Table 1.1

$d/$	$F/$
	2.9
	2.5
	2.2
	1.8
	1.5
	1.2
	0.8

- (i) Record the d values in the table.
(ii) Complete the column headings in the table.

[2]

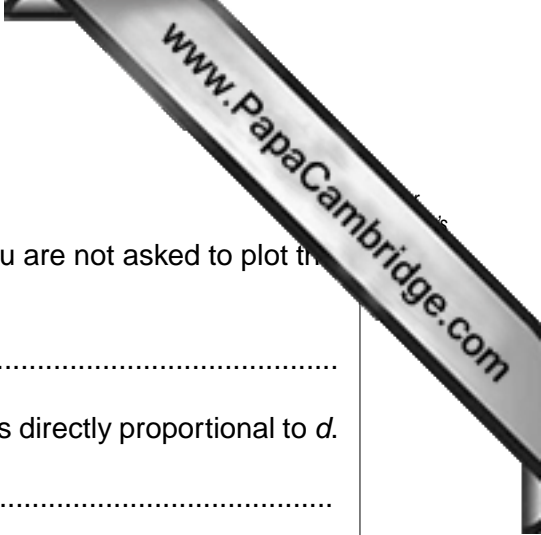

(b) The student thinks that F is directly proportional to d .

(i) Suggest the graph that you could plot to test this idea. You are not asked to plot the graph.

..... against

(ii) State the properties of the line that would indicate that F is directly proportional to d .

1.

2.

[3]

(c) A spirit level is a piece of equipment that is placed on a surface to check whether the surface is horizontal.

Suggest why a spirit level balanced on the rule is not suitable for checking whether the rule is horizontal in this experiment.

.....

.....[1]

(d) Describe briefly how you would check that the rule is horizontal in this experiment. You may draw a diagram.

.....

.....

.....[1]

[Total: 7]

- 2 The IGCSE class is investigating the rate of cooling of water.

Fig. 2.1 shows the apparatus.

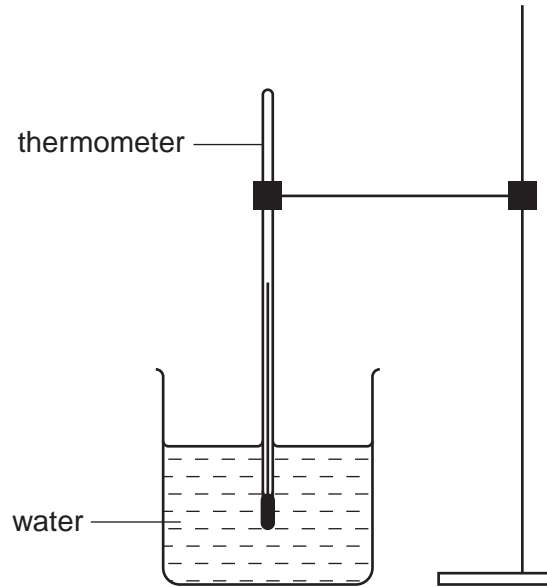
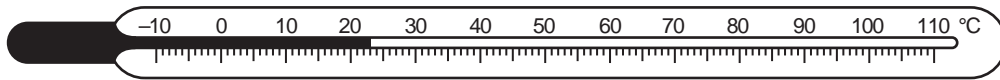

Fig. 2.1

- (a) Record the value of room temperature θ_R shown on the thermometer.



$$\theta_R = \dots\dots\dots[1]$$

- (b) A student pours approximately 200 cm^3 of hot water into the beaker. She measures the temperature θ of the water. She starts a stopclock and records the temperature θ of the water at 30 s intervals up to time $t = 150\text{ s}$. The readings are shown in Table 2.1.

Table 2.1

t/s	$\theta/^\circ\text{C}$
0	86
30	75
60	67
90	61
120	56
150	52

Plot a graph of $\theta/^\circ\text{C}$ (y -axis) against t/s (x -axis).

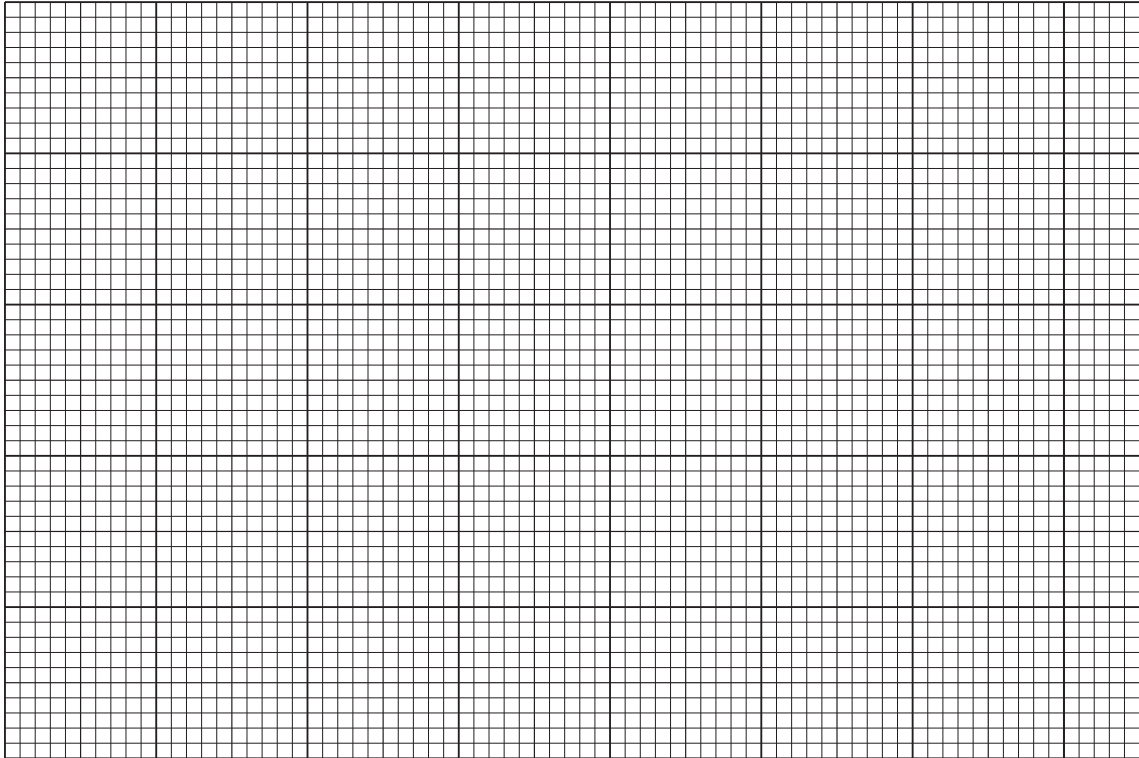

[5]

- (c) As you read these words, this experiment is actually being carried out by candidates in many different countries, using identical apparatus.

Suggest two differences in the conditions in the various laboratories that might lead to different graphs.

1.

2.

[2]

[Total: 8]

3 The IGCSE class is investigating resistor combinations in circuits.

The first circuit used is shown in Fig. 3.1.

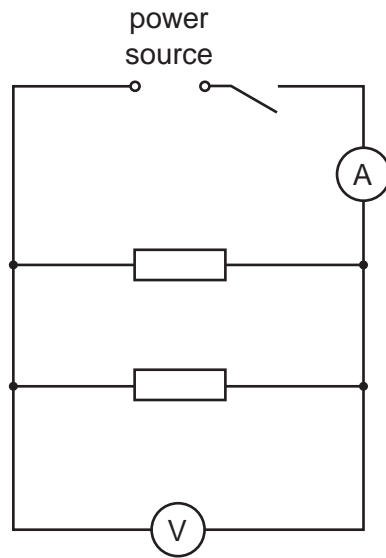

Fig. 3.1

(a) A student measures the potential difference V_1 across the resistors and the current I_1 in the circuit. The readings are shown in Figs. 3.2 and 3.3.

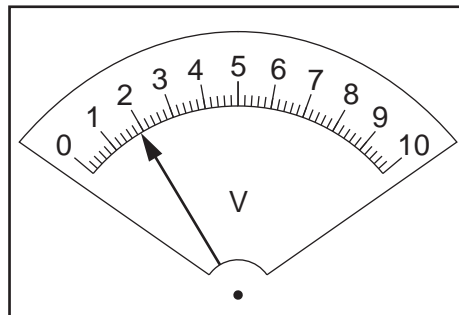

Fig. 3.2

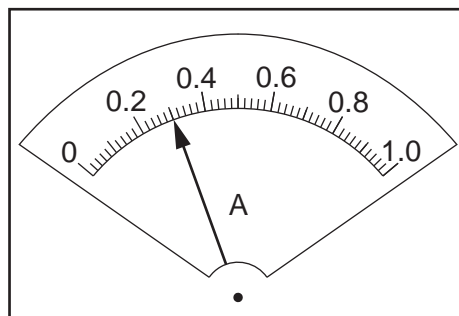

Fig. 3.3

(i) Record the potential difference V_1 and the current I_1 .

$V_1 = \dots\dots\dots$

$I_1 = \dots\dots\dots$

- (ii) Calculate the total resistance R_p of the combination of the two resistors arranged in parallel using the equation $R_p = \frac{V_1}{I_1}$.

$$R_p = \dots\dots\dots$$

- (iii) Calculate $4R_p$.

$$4R_p = \dots\dots\dots$$

[2]

- (b) The student rearranges the circuit so that the two resistors are connected in **series** and the voltmeter is connected to measure the potential difference across **both** resistors.

The new potential difference and current readings are $V_2 = 1.9\text{V}$ and $I_2 = 0.08\text{A}$.

Calculate the total resistance R_s of the combination of the two resistors arranged in series using the equation $R_s = \frac{V_2}{I_2}$.

$$R_s = \dots\dots\dots[1]$$

- (c) Theory suggests that $R_s = 4R_p$ if the two resistors have the same value. State whether your results indicate that the resistors have the same value. Justify your answer with reference to the results.

statement

justification

.....

[1]

- (d) Using the circuit described in (b), the student replaces the two series resistors with two lamps.

In the space below, draw a circuit diagram of the new circuit using standard symbols.

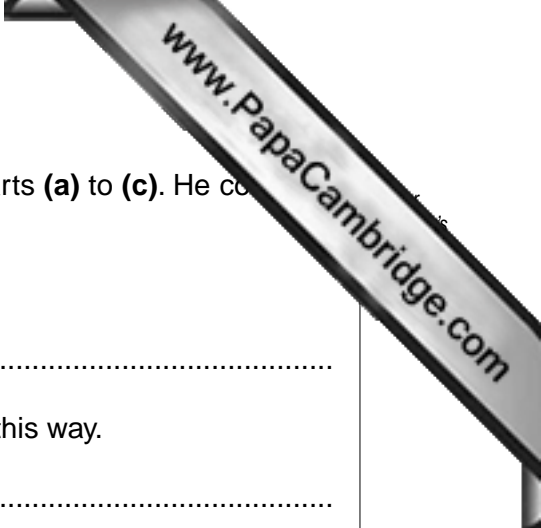

(e) A student suggests repeating the experiment described in parts (a) to (c). He connects a variable resistor between the power source and the switch.

(i) State the function of the variable resistor.

.....

(ii) Explain why you might want to use a variable resistor in this way.

.....

.....

[2]

[Total: 10]

4 A student is measuring some small glass spheres.

(a) The student has a 30 cm rule and two rectangular blocks of wood.

In the space below, draw a diagram to show clearly how you would arrange the apparatus to measure the diameter of **one** of the spheres.

[2]

- (b) The student then determines the average volume of a glass sphere by a displacement method. She pours some cold water into a measuring cylinder and records the volume V of the water, as shown in Fig. 4.1.

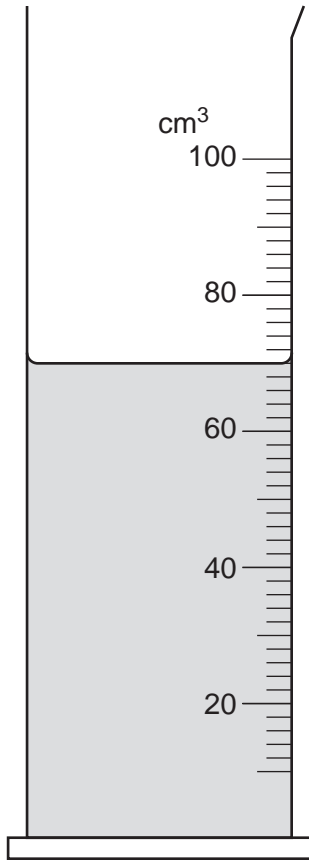

Fig. 4.1

- (i) On Fig. 4.1, show clearly the line of sight that you would use to obtain an accurate volume reading. [2]

- (ii) Using Fig. 4.1, record the volume V of water in the measuring cylinder.

$V = \dots\dots\dots$ [1]

- (iii) The student carefully puts 15 of the glass spheres into the measuring cylinder. The new water level reading is 78 cm^3 .

Calculate the volume V_1 of **one** sphere.

$V_1 = \dots\dots\dots$ [1]

- 5 The IGCSE class is determining the refractive index of the material of a transparent block.

Fig. 5.1 shows a student's ray-trace sheet.

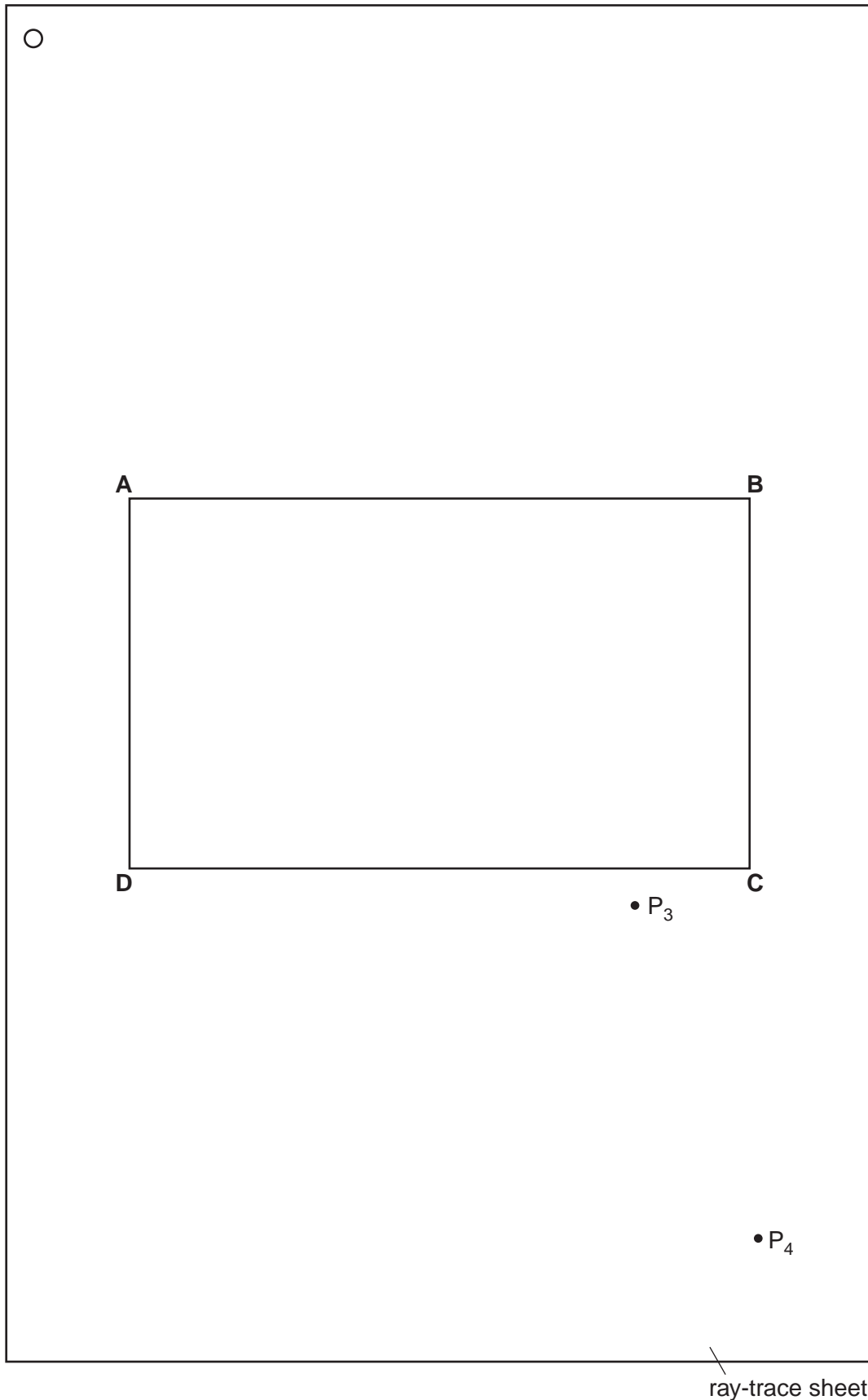
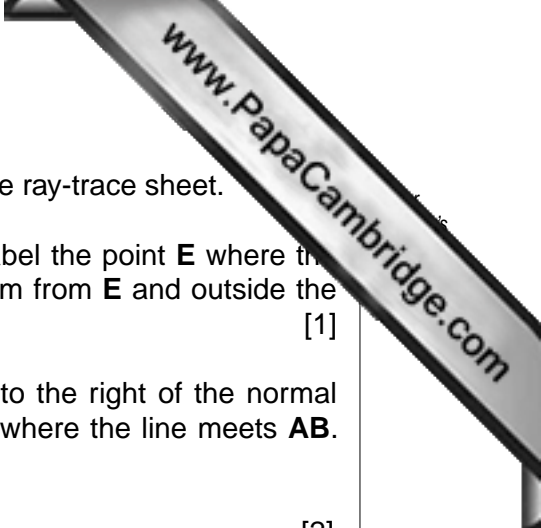

Fig. 5.1



(a) **ABCD** is a transparent block placed, largest face down, on the ray-trace sheet.

(i) On Fig. 5.1, draw a normal at the centre of side **AB**. Label the point **E** where the normal crosses **AB**. Mark a point **N** on the normal 4.0 cm from **E** and outside the outline of the block. [1]

(ii) Draw a line **NF** from **N** to the block. This line must be to the right of the normal and at an angle of 20° to the normal. Mark the point **F** where the line meets **AB**. Measure and record the length *a* of the line **NF**.

a = [2]

(b) The student places two pins P_1 and P_2 on the line through **F** and **N**. She observes the images of P_1 and P_2 through side **CD** of the block so that the images of P_1 and P_2 appear one behind the other.

She places two pins P_3 and P_4 between her eye and the block so that P_3 and P_4 and the images of P_1 and P_2 , seen through the block, appear one behind the other. The positions of P_3 and P_4 are marked on Fig. 5.1.

(i) Draw a line joining the positions of P_3 and P_4 . Continue the line until it meets **CD**. Label this point **G**.

(ii) Draw the line **GF** and continue it until it meets the normal. Label this point **H**.

(iii) Measure and record the length *b* of the line **FH**.

b = [3]

(iv) Calculate the refractive index *n* of the material of the block, using the equation

$$n = \frac{b}{a}$$

n = [2]

(c) Suggest one precaution that you would take in this experiment to obtain readings that are as accurate as possible.

.....
 [1]

[Total: 9]

