



UNIVERSITY OF CAMBRIDGE INTERNATIONAL EXAMINATIONS
International General Certificate of Secondary Education

COMBINED SCIENCE

0653/01

Paper 1 Multiple Choice

October/November 2008

45 minutes

Additional Materials: Multiple Choice Answer Sheet
 Soft clean eraser
 Soft pencil (type B or HB is recommended)



READ THESE INSTRUCTIONS FIRST

Write in soft pencil.

Do not use staples, paper clips, highlighters, glue or correction fluid.

Write your name, Centre number and candidate number on the Answer Sheet in the spaces provided unless this has been done for you.

There are **forty** questions on this paper. Answer **all** questions. For each question there are four possible answers **A, B, C** and **D**.

Choose the **one** you consider correct and record your choice in **soft pencil** on the separate Answer Sheet.

Read the instructions on the Answer Sheet very carefully.

Each correct answer will score one mark. A mark will not be deducted for a wrong answer.

Any rough working should be done in this booklet.

A copy of the Periodic Table is printed on page 20.

This document consists of **18** printed pages and **2** blank pages.



- 1 The diagram shows a mesophyll cell from a green plant.

Where is the cell's DNA found?

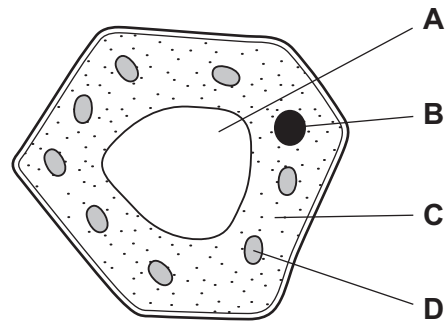

- 2 The diagram shows a leaf in sunlight and some of the substances that diffuse into and out of it.

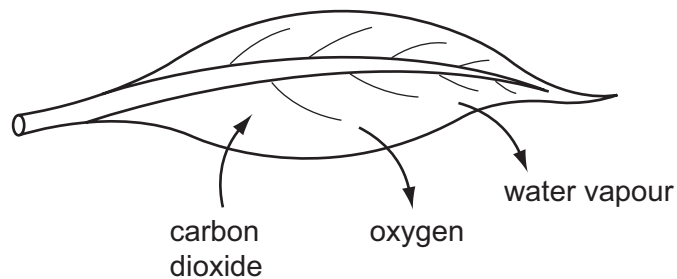

Which of the following has a higher concentration outside the leaf than inside the leaf?

- A** carbon dioxide only
B carbon dioxide and oxygen
C oxygen and water
D water vapour only
- 3 The diagrams show an experiment on enzyme activity.

The test-tubes contain equal volumes of solutions of catalase and hydrogen peroxide.

In which test-tube does the enzyme fail to work because it has been denatured?

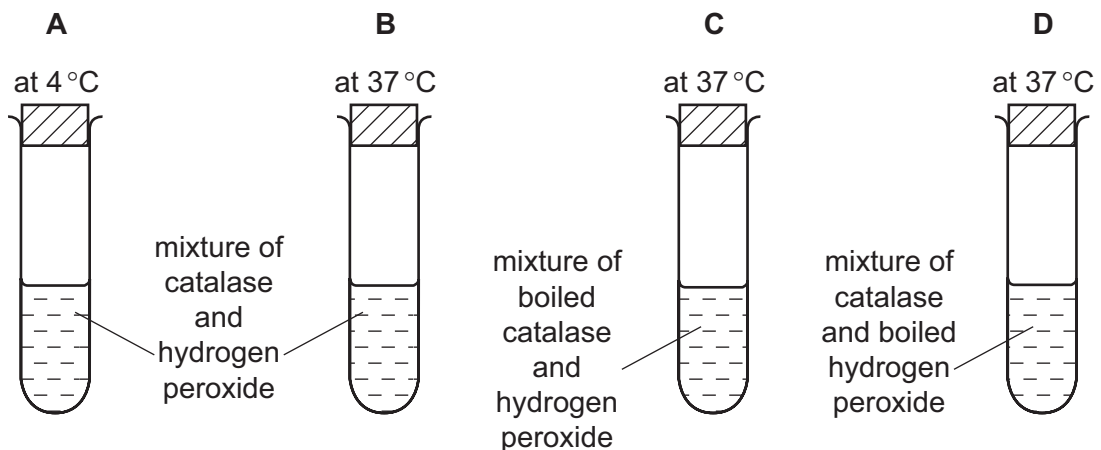

4 In which way do plants usually take in water from their surroundings?

- A as liquid through stomata
- B as liquid through root hairs
- C as vapour through stomata
- D as vapour through root hairs

5 A series of tests on a white liquid gave the following results.

test	result of test
Benedict's	an orange-red colour
biuret	a pale blue colour
iodine	a blue-black colour

What did the white liquid contain?

- A protein and starch only
- B protein and reducing sugar only
- C protein, reducing sugar and starch
- D reducing sugar and starch only

6 The diagram shows the thorax.

Which part has a lining containing goblet cells?

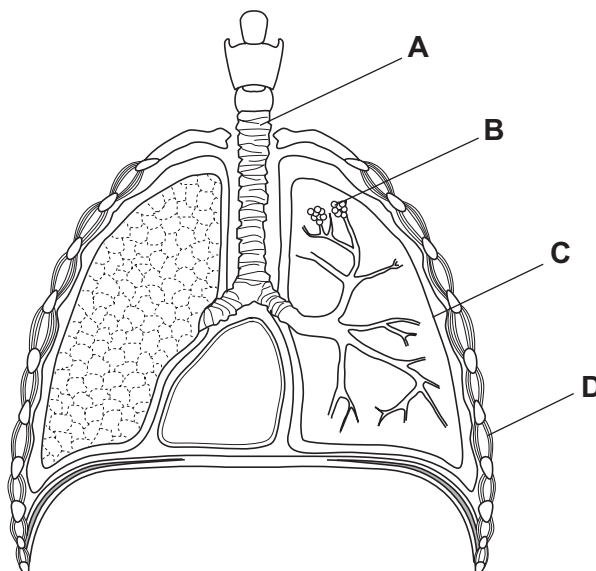

7 The diagram shows a section through the human heart.

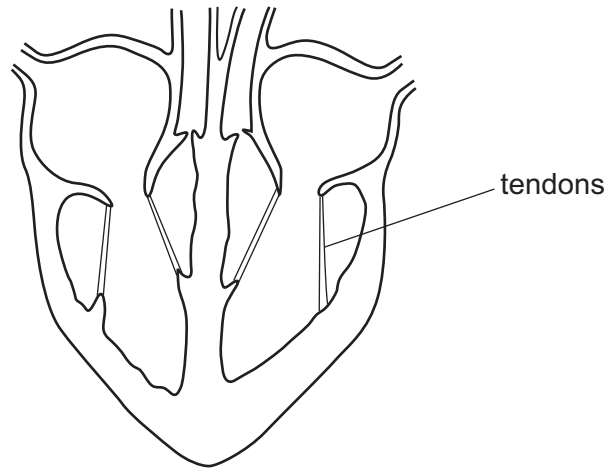

Which structures are joined by the tendons?

- A atrium wall and septum
- B atrium wall and valve
- C septum and ventricle wall
- D valve and ventricle wall

- 8 A plant shoot is left for several hours in a solution of red dye.

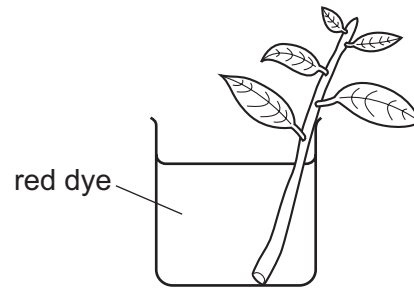

What is seen when a section is cut through a leaf and observed under a microscope?

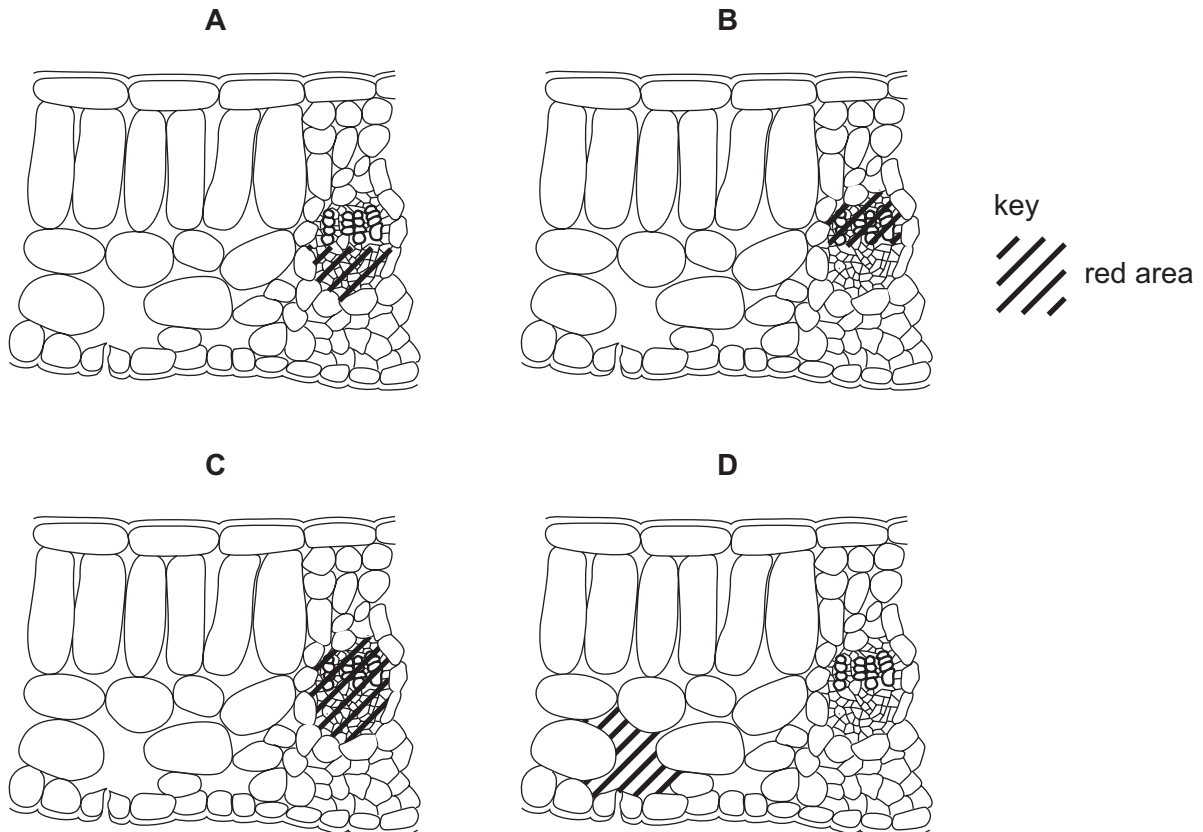

- 9 Which sequence shows the path of a signal through the nervous system when a person touches a hot object?
- A** central nervous system → effector → receptor
- B** effector → central nervous system → receptor
- C** effector → receptor → central nervous system
- D** receptor → central nervous system → effector

10 Which event that happens in the ovary of a flower starts seed formation?

- A conservation
- B fertilisation
- C germination
- D pollination

11 Which is **not** responsible for variation in characteristics in a plant?

- A chromosomes
- B cloning
- C environment
- D genes

12 The diagram shows part of the carbon cycle.

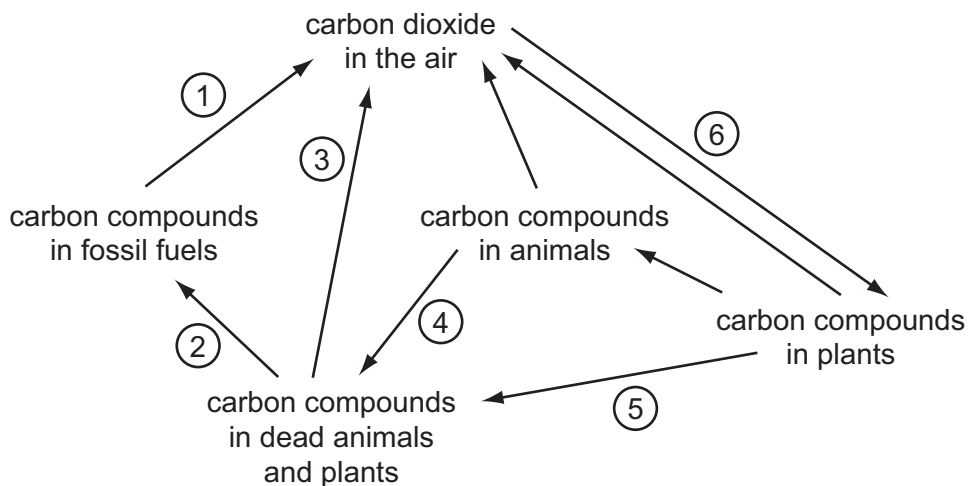

During which stage in the cycle will oxygen be added to the air?

- A 1
- B 3
- C 5
- D 6

13 Which are possible harmful effects of deforestation?

	global warming	reduced species diversity	soil erosion
A	✓	✓	✓
B	✓	✓	✗
C	✓	✗	✗
D	✗	✓	✓

key

✓ = yes

✗ = no

14 The symbol for an atom of neon is ${}_{10}^{20}\text{Ne}$.

Which statement about the atom is correct?

- A It contains half as many neutrons as protons.
- B It contains twice as many neutrons as protons.
- C The number of neutrons equals the number of protons.
- D The total number of neutrons and protons is thirty.

15 On heating iron and sulphur together, the mixture starts to glow. The glow then continues even when the heating is stopped.

In this reaction,1..... heat is given out and a new2..... is formed.

Which words correctly complete gaps 1 and 2?

	1	2
A	no	element
B	no	compound
C	some	element
D	some	compound

16 Which gases have covalent molecules that contain one or more double bonds?

	carbon dioxide	ethene	hydrogen chloride
A	✓	✓	✓
B	✓	✓	x
C	x	✓	✓
D	x	x	✓

17 What does a word equation show?

	the changes that occur in a reaction	the speed of a reaction
A	✓	✓
B	✓	x
C	x	✓
D	x	x

18 Which formula contains the most elements?

- A NaOH B Rb₂S C SiCl₄ D SnO₂

19 Urea, (NH₂)₂CO, is used as a fertiliser.

How many atoms or molecules are combined in urea?

- A atoms: nitrogen, 1; hydrogen, 2; carbon, 2; oxygen, 2
 B atoms: nitrogen, 2; hydrogen, 4; carbon, 1; oxygen, 1
 C molecules: ammonia, 1; carbon monoxide, 2
 D molecules: ammonia, 2; carbon monoxide, 1

20 Copper(II) oxide is mixed with solid Q.

On heating the mixture, a reaction occurs and the limewater turns cloudy.

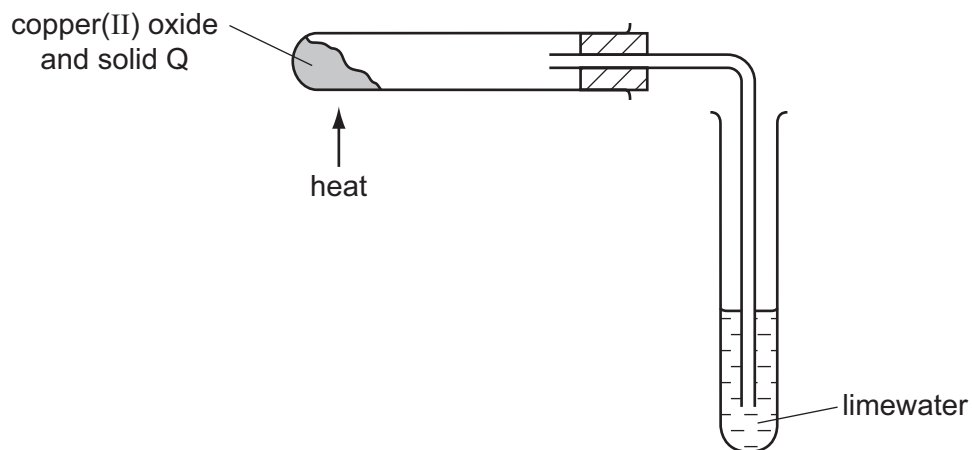

What is solid Q?

- A carbon
 B iron
 C sulphur
 D zinc

21 What is an alloy?

- A a compound containing two metallic elements
 B a compound containing two non-metallic elements
 C a mixture containing two metallic elements
 D a mixture containing two non-metallic elements

22 Impure copper is purified by electrolysis, as shown.

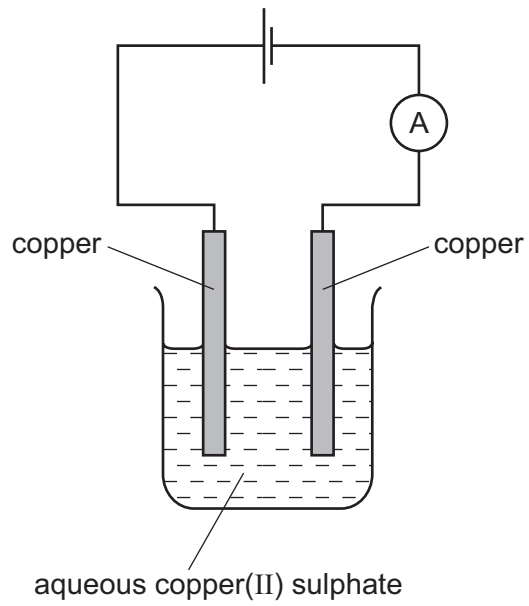

What is the cathode made of and how does its mass change during the electrolysis?

	the cathode is made of	its mass
A	impure copper	decreases
B	impure copper	increases
C	pure copper	decreases
D	pure copper	increases

23 The diagrams show an experiment.

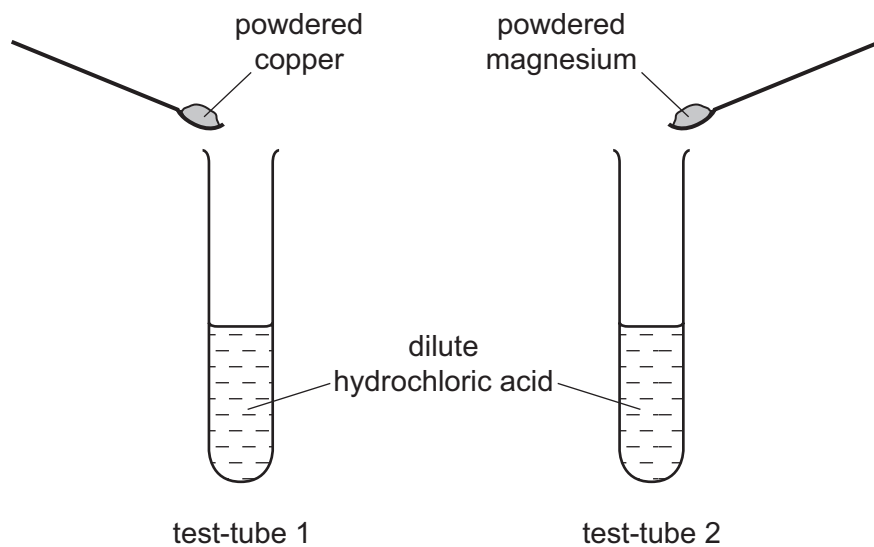

Each element is added until there is no further reaction. Universal Indicator solution is then added to each test-tube.

What are the colours of the indicator in the two test-tubes?

	test-tube 1	test-tube 2
A	blue	green
B	blue	red
C	red	green
D	red	red

24 When a mixture of hydrogen and oxygen is ignited, an explosive reaction occurs and water is formed.

Which terms describe this reaction?

	combustion	redox
A	✓	✓
B	✓	x
C	x	✓
D	x	x

25 Which diagram shows that an electrolyte is present?

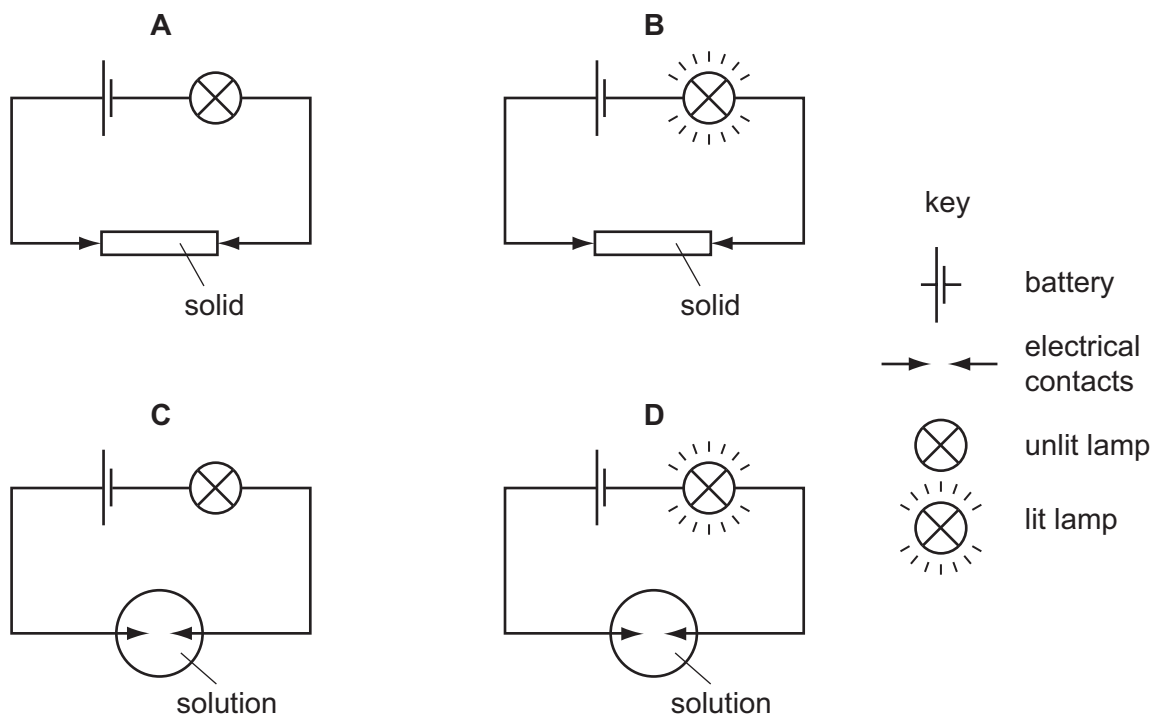

26 Which energy sources burn fossil fuels?

- 1 a coal-fired power station
- 2 a nuclear power station
- 3 an oil-fired power station

- A** 1 and 2 only
B 1 and 3 only
C 2 and 3 only
D 1, 2 and 3

27 Some plastics have long chain molecules that are made from molecules called X.

The molecules of X are most commonly obtained from Y.

What are X and Y?

	X	Y
A	monomers	coal
B	monomers	oil
C	polymers	coal
D	polymers	oil

- 28 Two digital stopwatches X and Y, which record in minutes and seconds, are used to time a race. The readings of the two stopwatches, at the start and at the end of the race, are shown.

	start	end
X	00:00	00:40

	start	end
Y	01:30	02:20

Which statement about the time of the race is correct?

- A** Both stopwatches recorded the same time interval.
B Stopwatch X recorded 10 s longer than stopwatch Y.
C Stopwatch Y recorded 10 s longer than stopwatch X.
D Stopwatch Y recorded 50 s longer than stopwatch X.
- 29 A car travels at various speeds during a short journey. The table shows the distances travelled and the time taken during each of four stages P, Q, R and S.

stage	P	Q	R	S
distance travelled / km	1.8	3.6	2.7	2.7
time taken / minutes	2	2	4	3

During which two stages is the car travelling at the same speed?

- A** P and Q **B** P and S **C** Q and R **D** R and S

- 30 Two identical measuring cylinders containing different liquids are placed on a simple balance. They balance as shown.

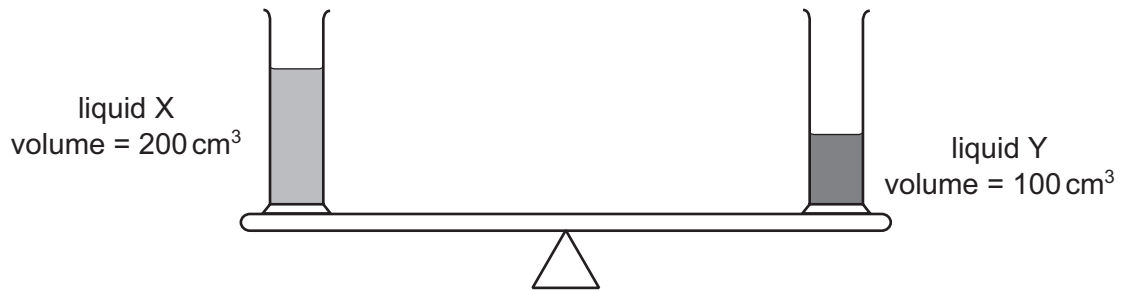

How does the density of X compare with the density of Y?

- A density of X = $\frac{1}{2}$ × density of Y
- B density of X = density of Y
- C density of X = 2 × density of Y
- D density of X = 4 × density of Y
- 31 A student carries out an experiment to plot the extension-load graph for a spring. The diagrams show the apparatus at the start of the experiment and with a load added.

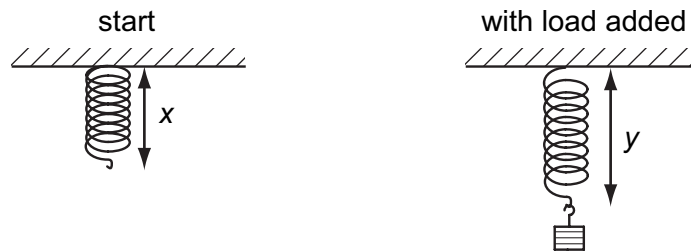

What is the extension caused by the load?

- A x B y C $y + x$ D $y - x$

32 The diagram shows water stored behind a dam.

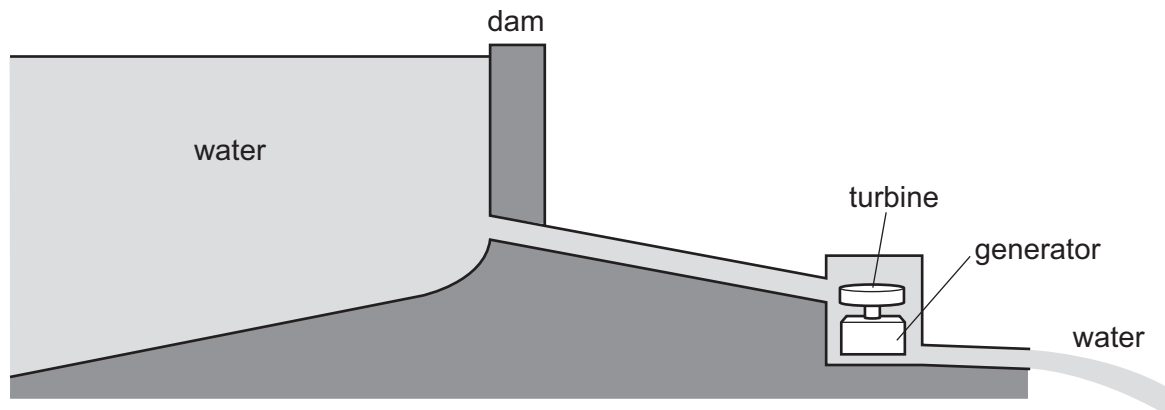

The water flows to a turbine and turns a generator.

Which sequence for the conversion of energy is correct?

- A potential energy → kinetic energy → electrical energy
- B kinetic energy → potential energy → electrical energy
- C potential energy → electrical energy → kinetic energy
- D kinetic energy → electrical energy → potential energy

33 A rubber ball is dropped from a height of 2 metres onto a table.

Whilst in contact with the table, some of its energy is converted into heat energy.

What is the highest possible point the ball could reach after bouncing?

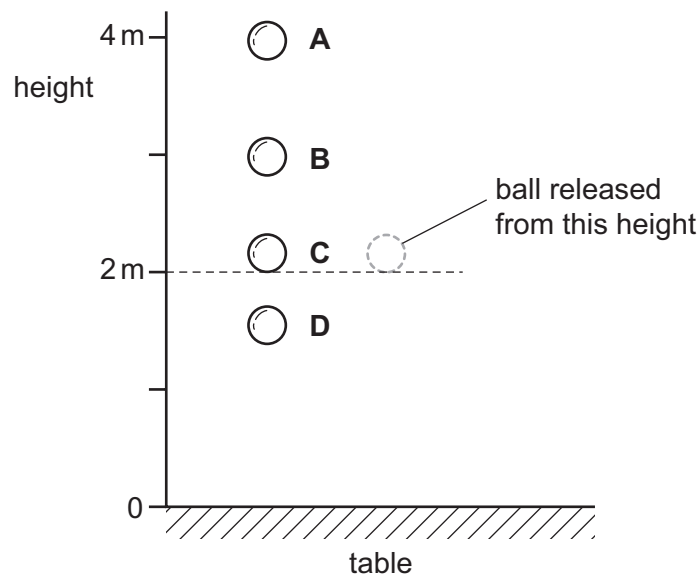

- 34 An engineer wants to fix a steel washer onto a steel rod. The rod is just too big to fit into the hole of the washer.

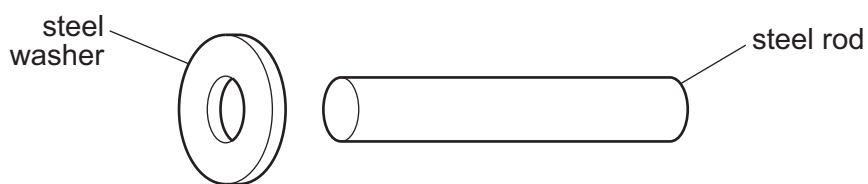

How can the engineer fit the washer onto the rod?

- A Cool the washer and put it over the rod.
 - B Cool the washer and rod to the same temperature and push them together.
 - C Heat the rod and then place it in the hole.
 - D Heat the washer and then place it over the rod.
- 35 A white plastic lid is placed on a plastic cup used for a hot drink.

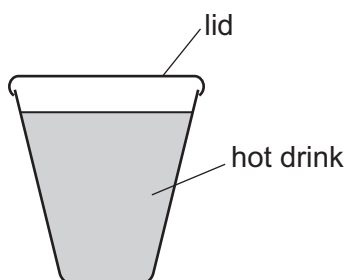

This would have no effect on the loss of heat by

- A conduction.
 - B convection.
 - C evaporation.
 - D radiation.
- 36 In the diagram, the distance OP is the focal length of the lens.

Through which point will the ray shown pass, after refraction by the lens?

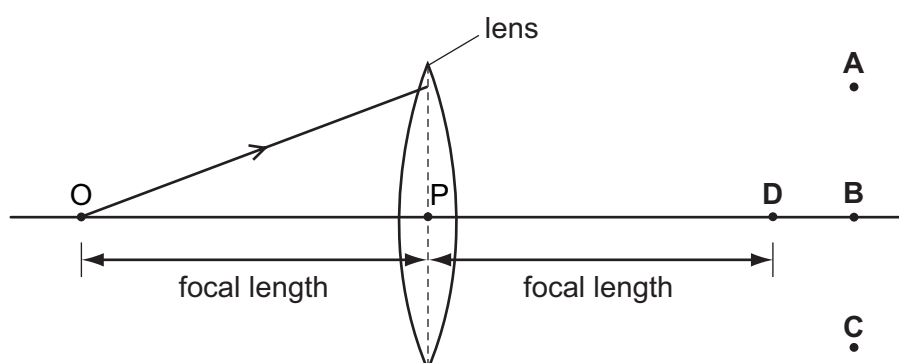

37 The table shows the voltage and current ratings for four electric heaters.

Which heater has the least resistance?

	voltage/V	current/A
A	110	5.0
B	110	10.0
C	230	5.0
D	230	10.0

38 In the circuit below, X and Y are identical 6 V lamps.

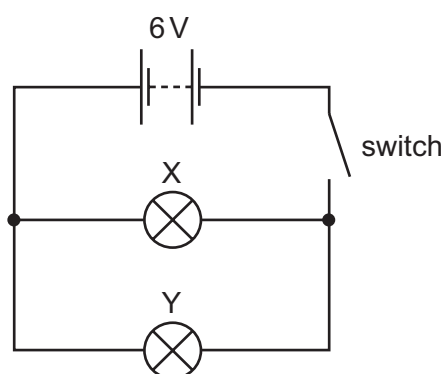

What happens when the switch is closed (switched on)?

- A** X lights more brightly than Y.
 - B** Y lights more brightly than X.
 - C** X and Y both light with full brightness.
 - D** X and Y both light with half brightness.
- 39 Two different systems are used to transmit equal amounts of electrical power from one building to another.

One system uses low voltage and the other uses high voltage.

Which line in the table is correct about which system wastes least energy and why?

	least energy wasted	why
A	high voltage system	the current in the wires is bigger
B	high voltage system	the current in the wires is smaller
C	low voltage system	the current in the wires is bigger
D	low voltage system	the current in the wires is smaller

40 Which type of radiation can be stopped by a sheet of paper?

- A alpha-particles
- B beta-particles
- C gamma-rays
- D X-rays

BLANK PAGE

BLANK PAGE

DATA SHEET
The Periodic Table of the Elements

		Group												
I	II	III	IV	V	VI	VII	0							
7 Li Lithium 3	9 Be Beryllium 4	1 H Hydrogen 1	11 B Boron 5	12 C Carbon 6	14 N Nitrogen 7	16 O Oxygen 8	19 F Fluorine 9	20 Ne Neon 10	27 Al Aluminium 13	28 Si Silicon 14	31 P Phosphorus 15	32 S Sulphur 16	35.5 Cl Chlorine 17	40 Ar Argon 18
39 K Potassium 19	40 Ca Calcium 20	55 Mn Manganese 25	56 Fe Iron 26	59 Co Cobalt 27	59 Ni Nickel 28	64 Cu Copper 29	65 Zn Zinc 30	70 Ga Gallium 31	73 Ge Germanium 32	75 As Arsenic 33	79 Se Selenium 34	80 Br Bromine 35	84 Kr Krypton 36	
85 Rb Rubidium 37	88 Sr Strontium 38	91 Zr Zirconium 40	91 Nb Niobium 41	93 Nb Niobium 41	96 Mo Molybdenum 42	101 Ru Ruthenium 44	106 Pd Palladium 46	108 Ag Silver 47	112 Cd Cadmium 48	115 In Indium 49	119 Sn Tin 50	122 Sb Antimony 51	127 I Iodine 53	131 Xe Xenon 54
133 Cs Caesium 55	137 Ba Barium 56	141 Pr Praseodymium 59	144 Nd Neodymium 60	145 Pm Promethium 61	150 Sm Samarium 62	152 Eu Europium 63	157 Gd Gadolinium 64	159 Tb Terbium 65	162 Dy Dysprosium 66	165 Ho Holmium 67	167 Er Erbium 68	169 Tm Thulium 69	173 Yb Ytterbium 70	175 Lu Lutetium 71
226 Ra Radium 88	227 Ac Actinium 89	232 Th Thorium 90	238 U Uranium 92	238 Np Neptunium 93	238 Pu Plutonium 94	238 Am Americium 95	238 Cm Curium 96	238 Bk Berkelium 97	238 Cf Californium 98	238 Es Einsteinium 99	238 Fm Fermium 100	238 Md Mendelevium 101	238 No Nobelium 102	238 Lr Lawrencium 103
		140 Ce Cerium 58	141 Pr Praseodymium 59	144 Nd Neodymium 60	150 Sm Samarium 62	152 Eu Europium 63	157 Gd Gadolinium 64	159 Tb Terbium 65	162 Dy Dysprosium 66	165 Ho Holmium 67	167 Er Erbium 68	169 Tm Thulium 69	173 Yb Ytterbium 70	175 Lu Lutetium 71

*58-71 Lanthanoid series
†90-103 Actinoid series

a	X
Key	b

a = relative atomic mass
X = atomic symbol
b = proton (atomic) number

The volume of one mole of any gas is 24 dm³ at room temperature and pressure (r.t.p.).

Permission to reproduce items where third-party owned material protected by copyright is included has been sought and cleared where possible. Every reasonable effort has been made by the publisher (UCLES) to trace copyright holders, but if any items requiring clearance have unwittingly been included, the publisher will be pleased to make amends at the earliest possible opportunity.

University of Cambridge International Examinations is part of the Cambridge Assessment Group. Cambridge Assessment is the brand name of University of Cambridge Local Examinations Syndicate (UCLES), which is itself a department of the University of Cambridge.