



UNIVERSITY OF CAMBRIDGE INTERNATIONAL EXAMINATIONS
International General Certificate of Secondary Education

COMBINED SCIENCE

0653/12

Paper 1 Multiple Choice

May/June 2010

45 minutes

Additional Materials: Multiple Choice Answer Sheet
Soft clean eraser
Soft pencil (type B or HB is recommended)



READ THESE INSTRUCTIONS FIRST

Write in soft pencil.

Do not use staples, paper clips, highlighters, glue or correction fluid.

Write your name, Centre number and candidate number on the Answer Sheet in the spaces provided unless this has been done for you.

There are **forty** questions on this paper. Answer **all** questions. For each question there are four possible answers **A, B, C** and **D**.

Choose the **one** you consider correct and record your choice in **soft pencil** on the separate Answer Sheet.

Read the instructions on the Answer Sheet very carefully.

Each correct answer will score one mark. A mark will not be deducted for a wrong answer.

Any rough working should be done in this booklet.

A copy of the Periodic Table is printed on page **16**.

This document consists of **16** printed pages.



1 Which part of a plant cell controls what enters and leaves the cell?

- A cell sap
- B cell surface membrane
- C cellulose cell wall
- D cytoplasm

2 The diagram shows the apparatus used in an investigation on gas exchange in organisms.

In which test-tube would the concentration of oxygen decrease most rapidly?

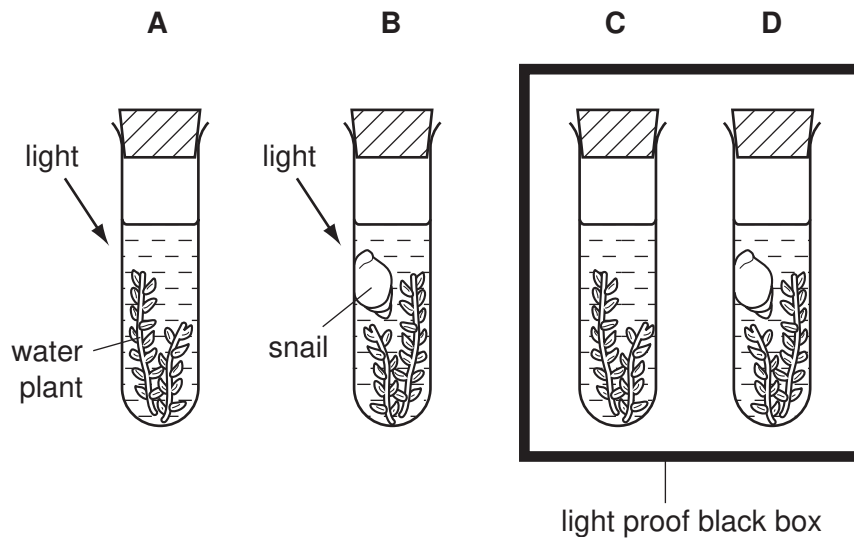

3 Which substances may diffuse into and out of plant cells?

	into plant cells	out of plant cells
A	chlorophyll	oxygen
B	oxygen	water
C	starch	chlorophyll
D	water	starch

4 The diagram shows a section through a leaf.

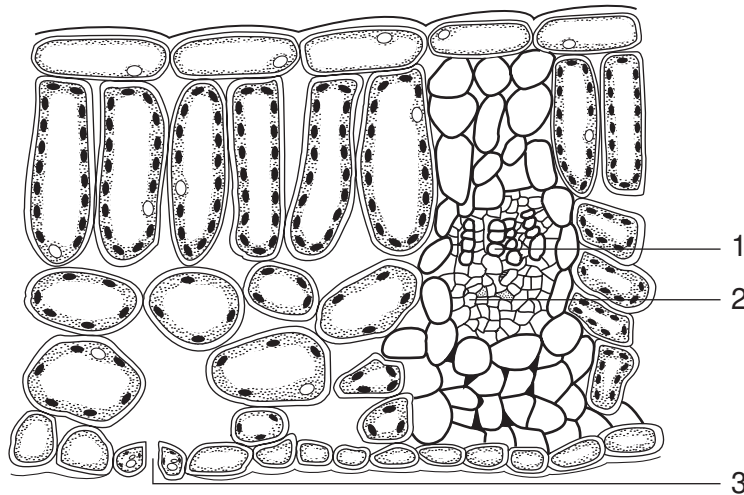

Which part brings water to the leaf and through which part does water leave the leaf?

	brings water	water leaves
A	1	2
B	1	3
C	2	1
D	3	1

5 The diagram shows a simple experiment using a solution of the enzyme catalase.

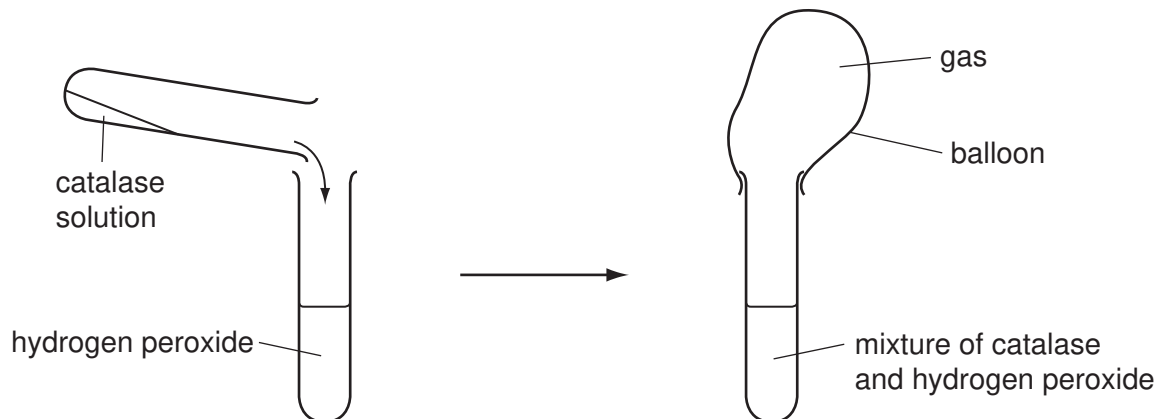

Which gas is collected in the balloon?

- A** carbon dioxide
- B** hydrogen
- C** nitrogen
- D** oxygen

- 6 The diagram shows some cells from the lining of the human trachea.

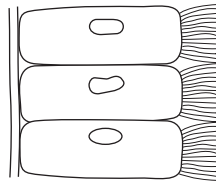

What is the function of these cells?

- A** absorption of oxygen into the blood
B excretion of carbon dioxide from the blood
C removal of mucus from the trachea
D secretion of mucus into the trachea
- 7 Which nutrients in the diet will help to prevent leg bones becoming deformed?
- A** calcium and vitamin C
B calcium and vitamin D
C iron and vitamin C
D iron and vitamin D
- 8 What effect does drinking alcohol have on the following:
- the rate at which signals pass along nerves,
 - the length of reaction time?

	rate at which signals pass along nerves	length of reaction time
A	faster	longer
B	faster	shorter
C	slower	longer
D	slower	shorter

- 9 The diagram shows four components of blood.

Which component contains haemoglobin?

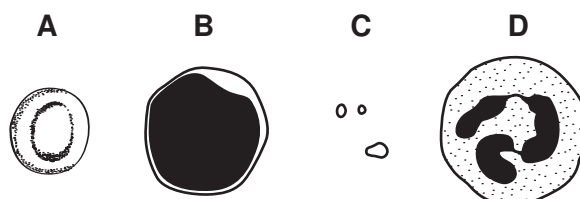

10 Rain forests have high species diversity.

What is meant by the term *species diversity*?

- A Members of a species in the forest are scattered over a wide area.
- B Members of a species show a wide range of variations.
- C There are many different species present.
- D The same species are found in many different rain forests in the world.

11 A variety of potato plant produces red tubers ('potatoes') that grow into new potato plants which then produce red 'potatoes' the following year.

Why is this?

- A Asexual reproduction produces identical potato plants.
- B Asexual reproduction results in different coloured 'potatoes'.
- C Sexual reproduction produces only red 'potatoes'.
- D Sexual reproduction requires the potato plant to produce flowers.

12 The diagram shows a section through a flower.

Where does fertilisation occur?

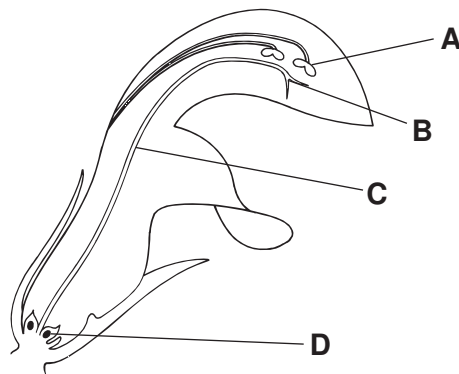

13 The table shows three ways in which different methods of birth control work.

Which correctly links the methods with how they work?

	prevents ovulation	prevents sperm release	prevents zygote implantation
A	IUD	sterilisation	cap
B	pill	rhythm	condom
C	pill	sterilisation	IUD
D	rhythm	condom	IUD

14 The diagram shows apparatus used to separate a mixture.

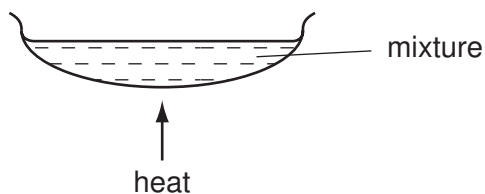

Which mixture could it be used to separate?

- A sand and salt
- B sand and sugar
- C salt and sugar
- D salt and water

15 A solid is ionic.

Which property best confirms this fact?

- A its behaviour as an electrolyte
- B its melting point
- C its solubility in water
- D the shape of its crystals

16 Which letter shows the position in the Periodic Table of an unreactive non-metal?

A																		
		B																C
																		D

17 Which diagram represents a mixture of elements?

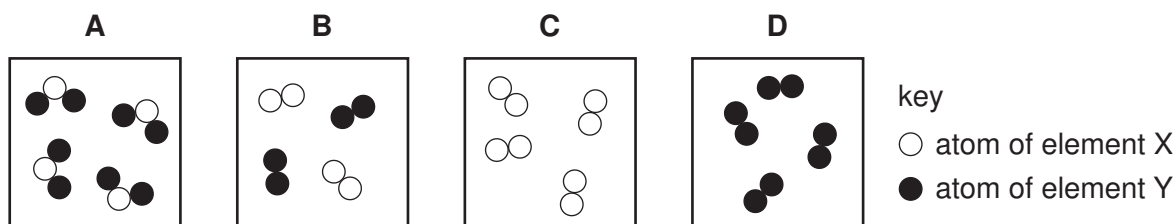

18 Which processes are used to purify the drinking water from reservoirs?

	chlorination	distillation	filtration
A	✓	✓	✓
B	✓	✓	x
C	✓	x	✓
D	x	✓	✓

19 The salt ammonium dichromate(VI) readily decomposes when heated.

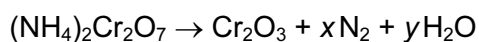

Which values of x and y make this equation balanced?

	x	y
A	1	2
B	1	4
C	2	2
D	2	4

20 Part of the apparatus used to electrolyse aqueous copper(II) chloride is shown.

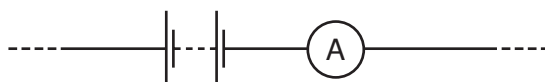

Which piece of apparatus is **not** required in this experiment?

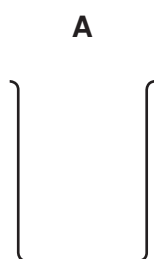

beaker



bulb

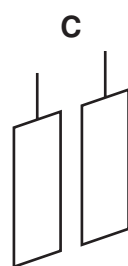

electrodes



electrolyte

21 Which method is used to obtain iron from iron(III) oxide?

- A** combustion
- B** electrolysis
- C** reduction
- D** thermal decomposition

22 A student carries out experiments with zinc and dilute hydrochloric acid.

Which change in conditions makes the reaction slower?

- A adding a suitable catalyst
- B increasing the concentration of the acid
- C increasing the particle size of the zinc
- D increasing the temperature

23 The table gives, for two metals, the colours of their solids and their aqueous ions.

metal	colour of	
	solid	aqueous ion
copper	red-brown	blue
zinc	grey	colourless

Equal amounts of powdered copper and powdered zinc are mixed together.

The mixture is added to dilute sulfuric acid in a test-tube until the acid is just used up. Some powder then remains at the bottom of the test-tube.

What are the colours of the remaining powder and the solution in the test-tube?

	powder	solution
A	grey	blue
B	grey	colourless
C	red-brown	blue
D	red-brown	colourless

24 A hydrocarbon is burned in excess oxygen.

The combustion products are passed through the apparatus shown.

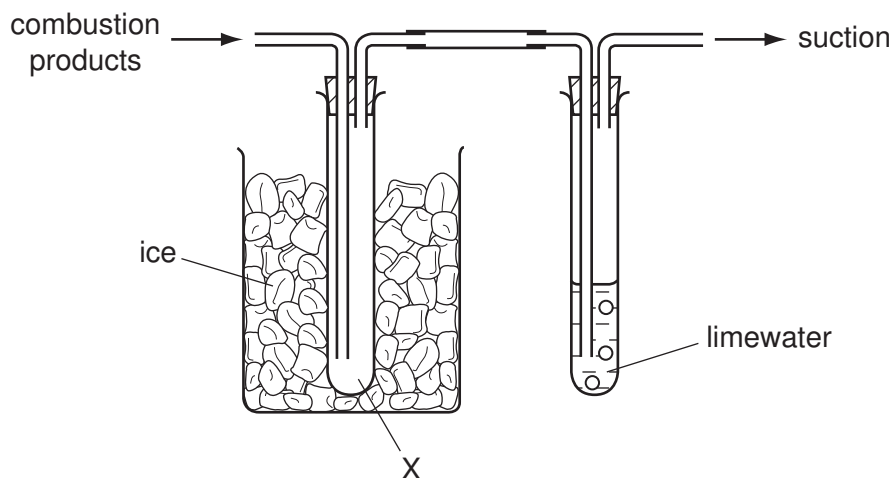

What collects at X and what happens to the limewater?

	collects at X	limewater turns
A	soot	cloudy
B	soot	red
C	water	cloudy
D	water	red

25 What happens to a piece of magnesium when it burns in air?

- A** oxidation and combustion
- B** oxidation and thermal decomposition
- C** reduction and combustion
- D** reduction and thermal decomposition

26 Coal, hydrogen, methane and gasoline (petrol) are commonly used as fuels.

How many of these fuels are solids, liquids or gases?

	solids	liquids	gases
A	0	2	2
B	1	1	2
C	1	2	1
D	2	2	0

27 This description of a plastic is incomplete.

To make a plastic,1..... of a2..... combine to form a long chain3..... .

Which words correctly complete the gaps?

	1	2	3
A	atoms	monomer	polymer
B	atoms	polymer	monomer
C	molecules	monomer	polymer
D	molecules	polymer	monomer

28 Water spilled on the ground on a hot day evaporates.

Which diagram represents the change in arrangement of the particles in the water as it evaporates?

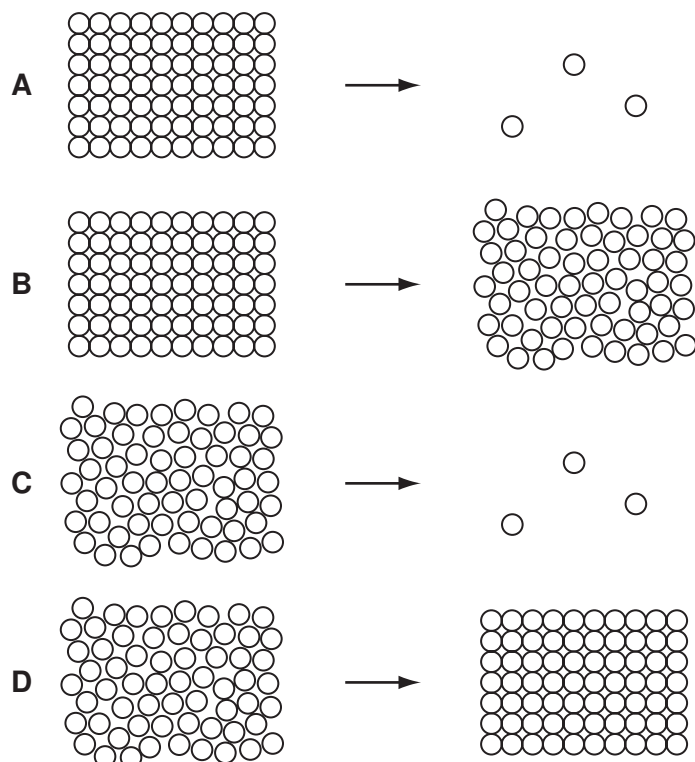

29 There is a vacuum between the double walls of a vacuum flask.

Which types of heat transfer are reduced by the vacuum?

- A** conduction and convection only
- B** conduction and radiation only
- C** convection and radiation only
- D** conduction, convection and radiation

- 30 In which situation would the object described be given an increase in its total energy?
- A a battery-powered torch being switched on
 - B a firework exploding
 - C a parachutist falling to the ground
 - D a skier being pulled up a slope
- 31 A tidal power station is made by building a barrage. At high tide the sea water is trapped behind the barrage.

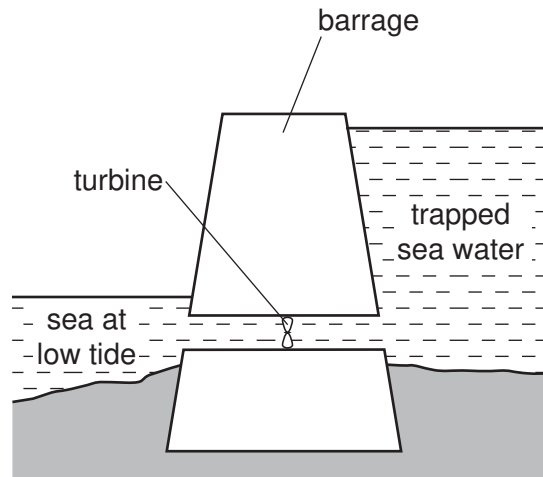

At low tide the water is allowed to flow back into the sea through a turbine.

What is the useful energy change in a tidal power station?

- A electrical energy \rightarrow kinetic energy
- B electrical energy \rightarrow potential energy
- C kinetic energy \rightarrow potential energy
- D potential energy \rightarrow electrical energy

32 In each of the circuits shown, identical resistors, cells and lamps are used.

In which circuit will the lamp glow most brightly?

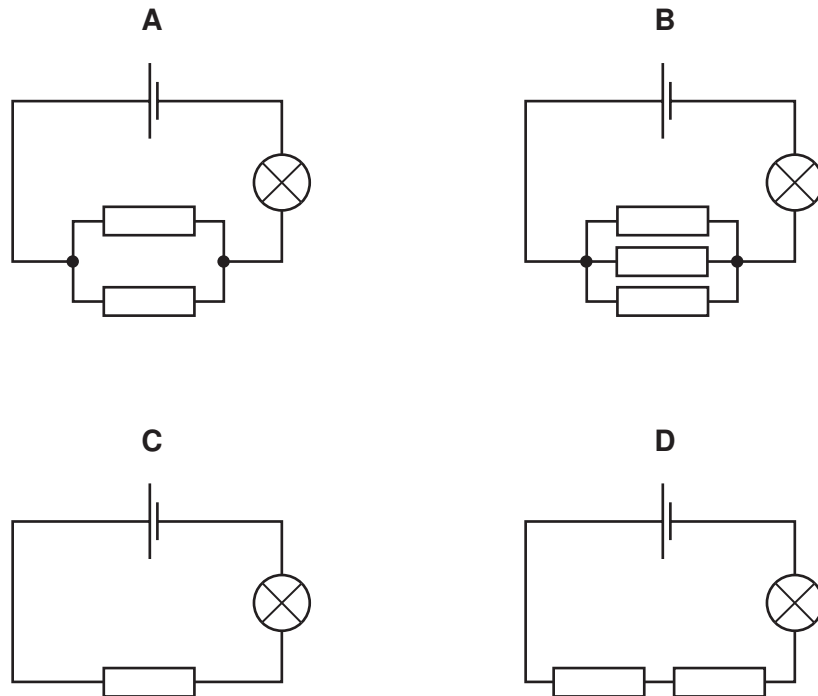

33 Electrical appliances are often fitted with a fuse.

What is the purpose of the fuse?

- A to adjust the voltage supplied to the correct value
- B to allow the appliance to be switched on by a small current
- C to cut the power supply if the appliance is used too often
- D to cut the power supply if the current becomes too large

34 A transformer has 2400 turns on its primary coil and 200 turns on its secondary coil.

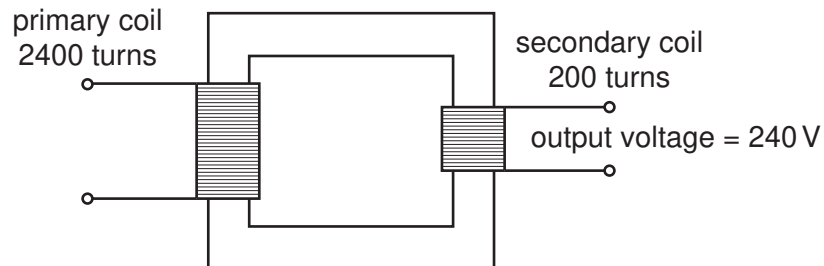

Assuming the transformer is 100 % efficient, what input voltage is needed to give an output voltage of 240V?

- A 12V
- B 20V
- C 240V
- D 2880V

- 35 The data from an aeroplane flight recorder is used to plot the speed / time graph for part of the flight.

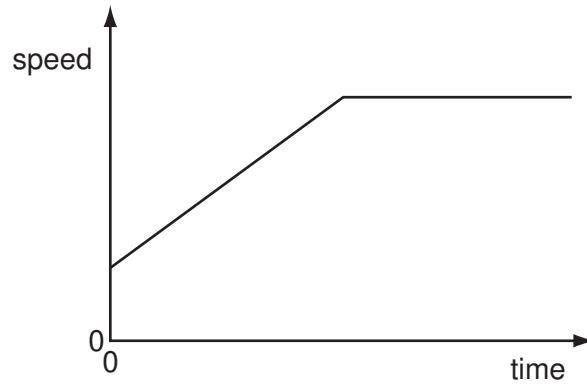

Which statement describes this part of the flight?

- A** The aeroplane accelerates from rest to a constant speed.
B The aeroplane decelerates after flying at a constant speed.
C The aeroplane reaches a constant speed after a period of changing speed.
D The aeroplane travels at an increasing speed followed by a decreasing speed.
- 36 Which statement is correct?
- A** Mass is a force.
B Mass is measured in newtons.
C Weight is a force.
D Weight is measured in kilograms.
- 37 The table shows the dimensions of four rectangular blocks.

Which block has a volume of 3 m^3 ?

	height / cm	width / cm	depth / cm
A	100	100	100
B	300	100	100
C	300	300	100
D	300	300	300

- 38 The diagrams show the wave patterns of four notes shown on a cathode ray oscilloscope. The oscilloscope controls are set the same for each sound.

Which note has the highest pitch?

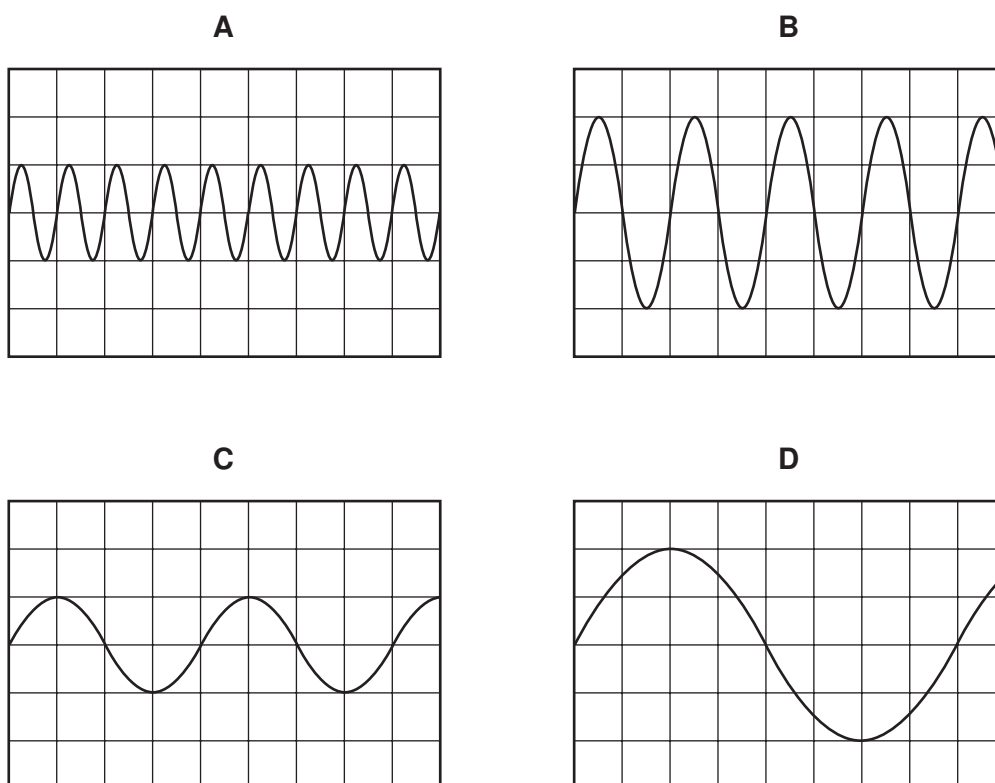

- 39 A ray diagram is drawn to locate the position of the image formed by a converging lens of focal length f .

Which ray **cannot** be drawn until the position of the image is known?

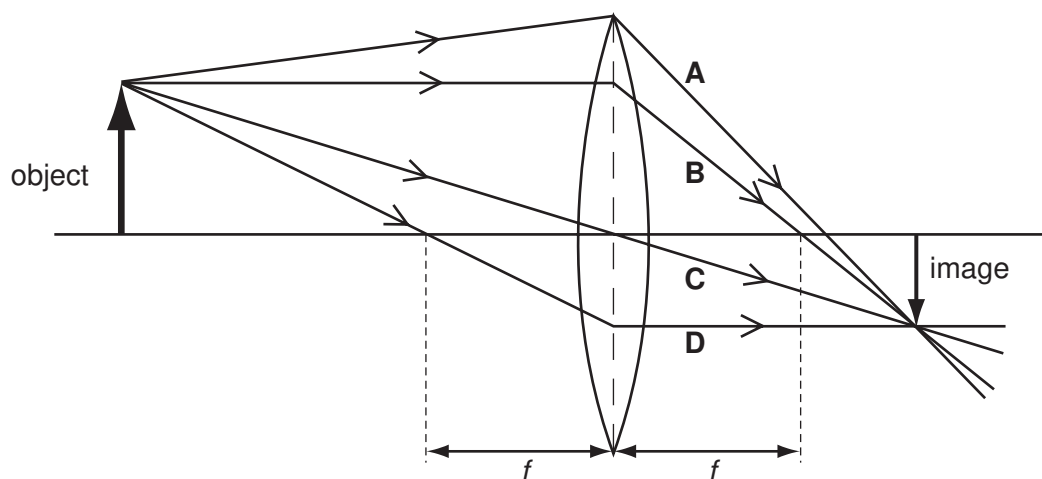

40 The diagram shows a radioactive source, a thick aluminium sheet and a radiation detector.

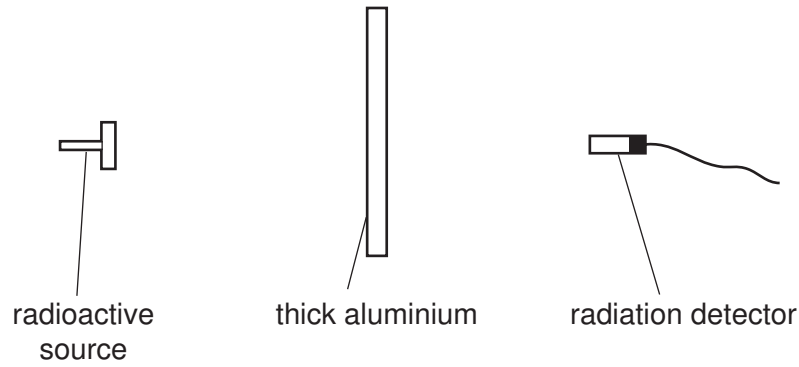

The radiation detector shows a reading greater than the background reading.

Which type of radiation is being emitted by the source and detected by the detector?

- A alpha-radiation
- B beta-radiation
- C gamma-radiation
- D infra-red radiation

DATA SHEET
The Periodic Table of the Elements

		Group																																															
		I	II	III	IV	V	VI	VII	0																																								
		1 H Hydrogen 1																																															
		4 He Helium 2																																															
7	9	3	4	5	6	7	8	9	10	11	12	13	14	15	16	17	18	19	20																														
Li Lithium	Be Beryllium	B Boron	C Carbon	N Nitrogen	O Oxygen	F Fluorine	Ne Neon	Na Sodium	Mg Magnesium	Al Aluminium	Si Silicon	P Phosphorus	S Sulfur	Cl Chlorine	Ar Argon	K Potassium	Ca Calcium	Sc Scandium	Ti Titanium	V Vanadium	Cr Chromium	Mn Manganese	Fe Iron	Co Cobalt	Ni Nickel	Cu Copper	Zn Zinc	Ga Gallium	Ge Germanium	As Arsenic	Se Selenium	Br Bromine	Kr Krypton																
11	12	13	14	15	16	17	18	19	20	21	22	23	24	25	26	27	28	29	30	31	32	33	34	35	36	37	38	39	40	41	42	43	44	45	46	47	48	49	50	51	52	53	54						
Na Sodium	Mg Magnesium	Al Aluminium	Si Silicon	P Phosphorus	S Sulfur	Cl Chlorine	Ar Argon	K Potassium	Ca Calcium	Sc Scandium	Ti Titanium	V Vanadium	Cr Chromium	Mn Manganese	Fe Iron	Co Cobalt	Ni Nickel	Cu Copper	Zn Zinc	Ga Gallium	Ge Germanium	As Arsenic	Se Selenium	Br Bromine	Kr Krypton	Rb Rubidium	Sr Strontium	Y Yttrium	Zr Zirconium	Nb Niobium	Mo Molybdenum	Tc Technetium	Ru Ruthenium	Rh Rhodium	Pd Palladium	Ag Silver	Cd Cadmium	In Indium	Sn Tin	Sb Antimony	Te Tellurium	I Iodine	Xe Xenon						
41	42	43	44	45	46	47	48	49	50	51	52	53	54	55	56	57	58	59	60	61	62	63	64	65	66	67	68	69	70	71	72	73	74	75	76	77	78	79	80	81	82	83	84	85	86				
Rb Rubidium	Sr Strontium	Y Yttrium	Zr Zirconium	Nb Niobium	Mo Molybdenum	Tc Technetium	Ru Ruthenium	Rh Rhodium	Pd Palladium	Ag Silver	Cd Cadmium	In Indium	Sn Tin	Sb Antimony	Te Tellurium	I Iodine	Xe Xenon	Cs Caesium	Ba Barium	La Lanthanum	Ce Cerium	Pr Praseodymium	Nd Neodymium	Pm Promethium	Sm Samarium	Eu Europium	Gd Gadolinium	Tb Terbium	Dy Dysprosium	Ho Holmium	Er Erbium	Tm Thulium	Yb Ytterbium	Lu Lutetium	Rn Radon														
87	88	89	90	91	92	93	94	95	96	97	98	99	100	101	102	103	104	105	106	107	108	109	110	111	112	113	114	115	116	117	118	119	120	121	122	123	124	125	126	127	128	129	130	131	132	133	134	135	136
Fr Francium	Ra Radium	Ac Actinium	Th Thorium	Pa Protactinium	U Uranium	Np Neptunium	Pu Plutonium	Am Americium	Cm Curium	Bk Berkelium	Cf Californium	Es Einsteinium	Fm Fermium	Md Mendelevium	No Nobelium	Lr Lawrencium	Cs Caesium	Ba Barium	La Lanthanum	Ce Cerium	Pr Praseodymium	Nd Neodymium	Pm Promethium	Sm Samarium	Eu Europium	Gd Gadolinium	Tb Terbium	Dy Dysprosium	Ho Holmium	Er Erbium	Tm Thulium	Yb Ytterbium	Lu Lutetium	Rn Radon															
87	88	89	90	91	92	93	94	95	96	97	98	99	100	101	102	103	104	105	106	107	108	109	110	111	112	113	114	115	116	117	118	119	120	121	122	123	124	125	126	127	128	129	130	131	132	133	134	135	136
Fr Francium	Ra Radium	Ac Actinium	Th Thorium	Pa Protactinium	U Uranium	Np Neptunium	Pu Plutonium	Am Americium	Cm Curium	Bk Berkelium	Cf Californium	Es Einsteinium	Fm Fermium	Md Mendelevium	No Nobelium	Lr Lawrencium	Cs Caesium	Ba Barium	La Lanthanum	Ce Cerium	Pr Praseodymium	Nd Neodymium	Pm Promethium	Sm Samarium	Eu Europium	Gd Gadolinium	Tb Terbium	Dy Dysprosium	Ho Holmium	Er Erbium	Tm Thulium	Yb Ytterbium	Lu Lutetium	Rn Radon															

*58-71 Lanthanoid series
†90-103 Actinoid series

a	X	b
Key	a = relative atomic mass X = atomic symbol b = proton (atomic) number	

The volume of one mole of any gas is 24 dm³ at room temperature and pressure (r.t.p.).

Permission to reproduce items where third-party owned material protected by copyright is included has been sought and cleared where possible. Every reasonable effort has been made by the publisher (UCLES) to trace copyright holders, but if any items requiring clearance have unwittingly been included, the publisher will be pleased to make amends at the earliest possible opportunity.

University of Cambridge International Examinations is part of the Cambridge Assessment Group. Cambridge Assessment is the brand name of University of Cambridge Local Examinations Syndicate (UCLES), which is itself a department of the University of Cambridge.

