



UNIVERSITY OF CAMBRIDGE INTERNATIONAL EXAMINATIONS  
International General Certificate of Secondary Education

CANDIDATE  
NAME

CENTRE  
NUMBER

--	--	--	--	--

CANDIDATE  
NUMBER

--	--	--	--

**COMBINED SCIENCE**

**0653/33**

Paper 3 (Extended)

**May/June 2010**

**1 hour 15 minutes**

Candidates answer on the Question Paper.

No Additional Materials are required.

**READ THESE INSTRUCTIONS FIRST**

Write your Centre number, candidate number and name on all the work you hand in.

Write in dark blue or black pen.

You may use a soft pencil for any diagrams, graphs, tables or rough working.

Do not use staples, paper clips, highlighters, glue or correction fluid.

**DO NOT WRITE IN ANY BARCODES.**

Answer **all** questions.

A copy of the Periodic Table is printed on page 20.

At the end of the examination, fasten all your work securely together.

The number of marks is given in brackets [ ] at the end of each question or part question.

**For Examiner's Use**

<b>1</b>	
<b>2</b>	
<b>3</b>	
<b>4</b>	
<b>5</b>	
<b>6</b>	
<b>7</b>	
<b>8</b>	
<b>9</b>	
<b>Total</b>	

This document consists of **20** printed pages.



1 (a) Fig. 1.1 shows four fruits.

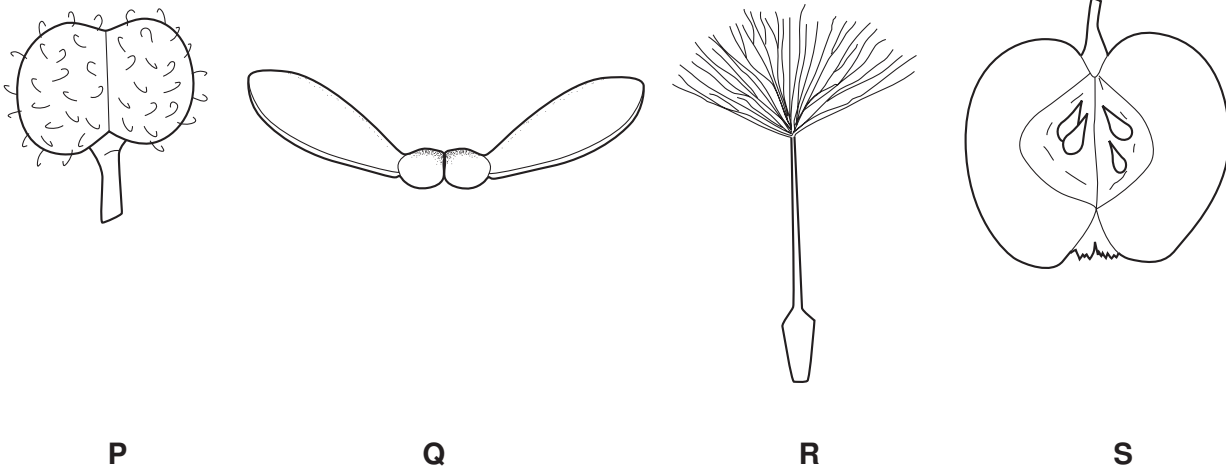

Fig. 1.1

(i) Give the letters of **two** fruits which are adapted for wind dispersal.

..... and ..... [1]

(ii) Name the part of a flower from which the fruit develops. .... [1]

(iii) Explain the importance of fruits in the life cycle of a plant.

.....  
.....  
..... [2]

(b) Cacao trees produce many pink and white flowers from which the fruits develop. The seeds inside the pods (fruits) are used to make chocolate.

Wild cacao trees grow in rainforests in warm, humid climates. Most kinds of trees cultivated by humans, such as rubber trees or oil palms, grow best on cleared land, but cacao trees grow best underneath other rainforest trees. Most cacao trees are grown without the use of fertilisers or pesticides.

(i) Suggest how the flowers of the cacao tree are pollinated, giving a reason for your answer.

..... [1]

- (ii) Explain why cultivating cacao trees may cause less damage to rainforests than cultivating other trees.

*For  
Examiner's  
Use*

.....

.....

.....

.....

.....

..... [3]

- 2 (a) A teacher placed a small piece of potassium into a container filled with chlorine gas.

Fig. 2.1 shows what the class observed.

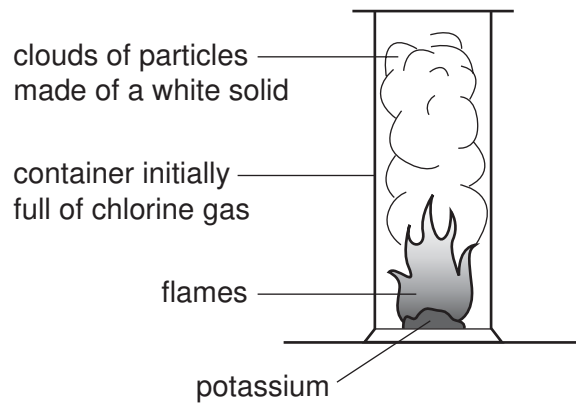

Fig. 2.1

- (i) Suggest the name of the white solid formed when potassium and chlorine react.

..... [1]

- (ii) Fig. 2.2 shows a potassium atom and a chlorine atom.

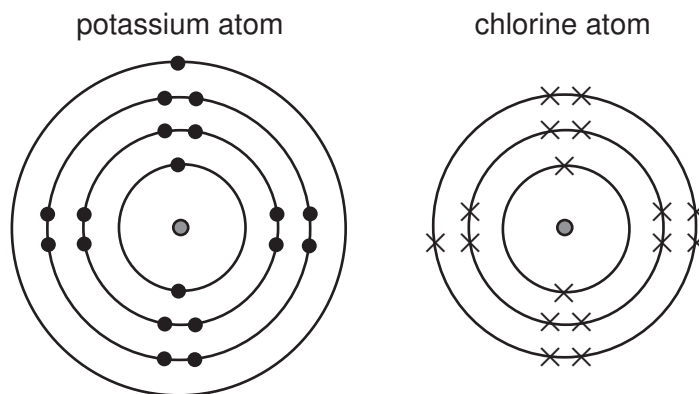

Fig. 2.2

Describe and explain, in terms of electronic structures, what happens when potassium and chlorine atoms react with each other. You may draw diagrams in the space below if it helps you to answer the question.

For  
Examiner's  
Use

.....  
.....  
.....  
..... [4]

(b) Metallic potassium can be produced by electrolysis of molten potassium chloride. In this process, potassium forms at the cathode.

(i) Explain why potassium ions travel to the cathode and **not** the anode during electrolysis.

.....  
.....  
..... [1]

(ii) Describe, in terms of electrons, what happens when potassium ions collide with the surface of the cathode.

.....  
.....  
..... [2]

- 3 (a) Fig. 3.1 shows an astronaut on a space walk. His space suit is designed to stop dangerous electromagnetic radiation from the Sun reaching the astronaut's body.

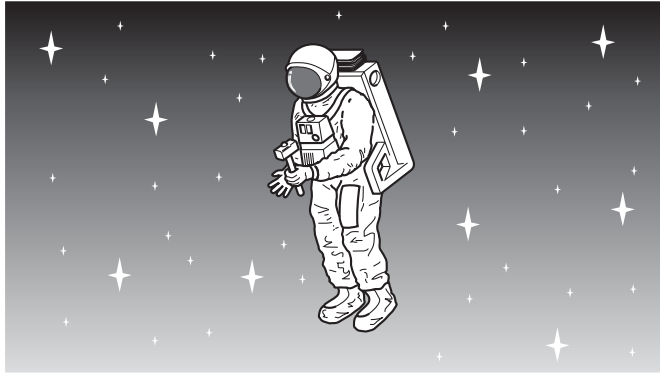

Fig. 3.1

- (i) Name **two** types of electromagnetic radiation that can harm the body.

1 ..... 2 ..... [1]

- (ii) State **one** way in which electromagnetic radiation can harm the body.

..... [1]

- (iii) All electromagnetic waves travel at the same speed. What is the value of this speed?

..... [1]

- (b) The astronaut has a mass of 96 kg. The gravitational field strength on the Moon is about one sixth of that on the Earth.

State the difference, if any, between

- (i) the mass of the astronaut on the Earth and on the Moon,

..... [1]

- (ii) the weight of the astronaut on the Earth and on the Moon.

..... [1]

- (c) The astronaut stands on the surface of the Moon and drops a ball. The graph in Fig. 3.2 shows the speed of the ball over a period of 1.6 seconds.

For  
Examiner's  
Use

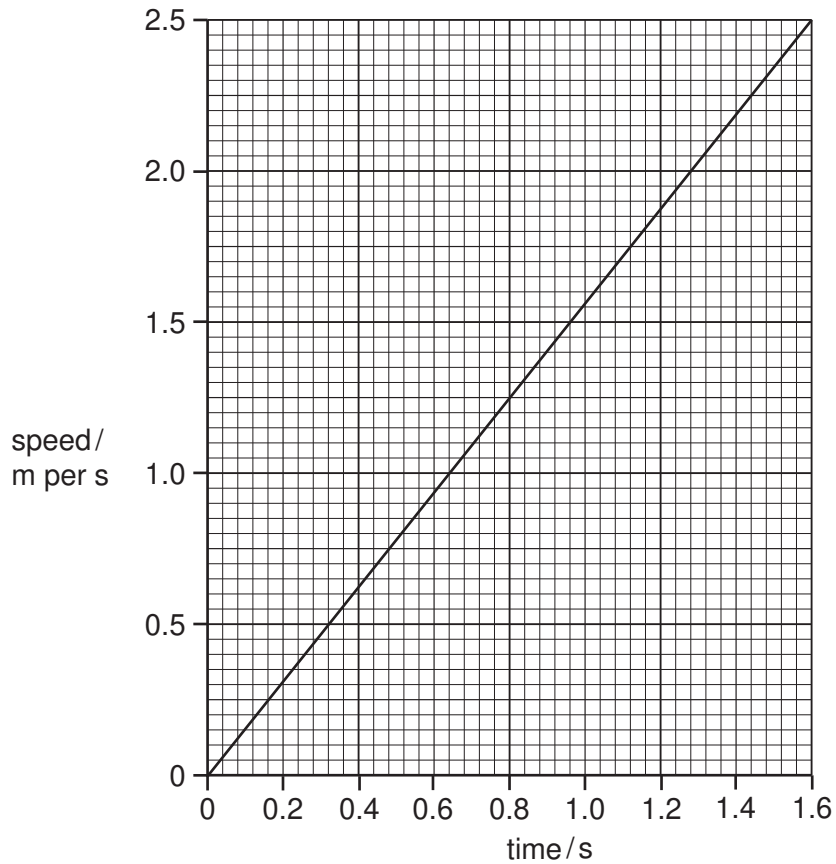

Fig. 3.2

- (i) On the same graph, sketch a line to show the speed of the same ball if it was dropped on Earth. [1]
- (ii) Explain your answer to (c)(i).

.....

..... [1]

(d) A rock on the Moon weighs 6 N. The astronaut lifts it up by 2 metres.

(i) Calculate the work done on the rock.

State the formula that you use and show your working.

formula

working

For  
Examiner's  
Use

..... [2]

(ii) If the rock was lifted in 2 seconds, calculate the power used.

State the formula that you use and show your working.

formula

working

..... [2]



4 Fig. 4.1 shows a section through a human heart, seen from the front.

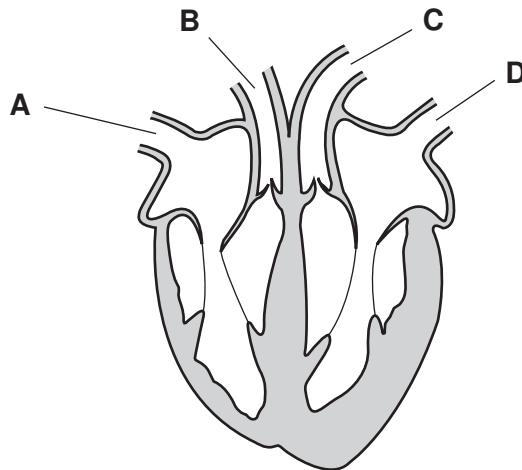

Fig. 4.1

(a) (i) Name the type of tissue found in the walls of the heart, as shown in the shaded parts in Fig. 4.1.

..... [1]

(ii) Describe how this tissue is supplied with oxygen.

.....  
 .....  
 ..... [2]

(iii) Give the letters of the **two** labelled blood vessels that contain oxygenated blood.

..... and ..... [1]

(b) Plants also have transport systems in which liquids flow through vessels. However, they do not have a pump like the heart.

(i) Explain what makes water flow up through the xylem vessels in a plant.

.....  
 .....  
 ..... [2]

(ii) Describe how sugars, made in a plant's leaves, are transported to its roots.

.....  
 .....  
 ..... [2]

5 (a) Some fuels are listed below.

animal dung
coal
wood

State **one** reason why coal is an example of a fossil fuel whereas the other two are not.

.....  
 ..... [1]

(b) Fig. 5.1 shows a simplified diagram of fractional distillation and catalytic cracking which are both carried out at an oil refinery. Compounds leaving the fractional distillation column at **M** move into the catalytic cracker.

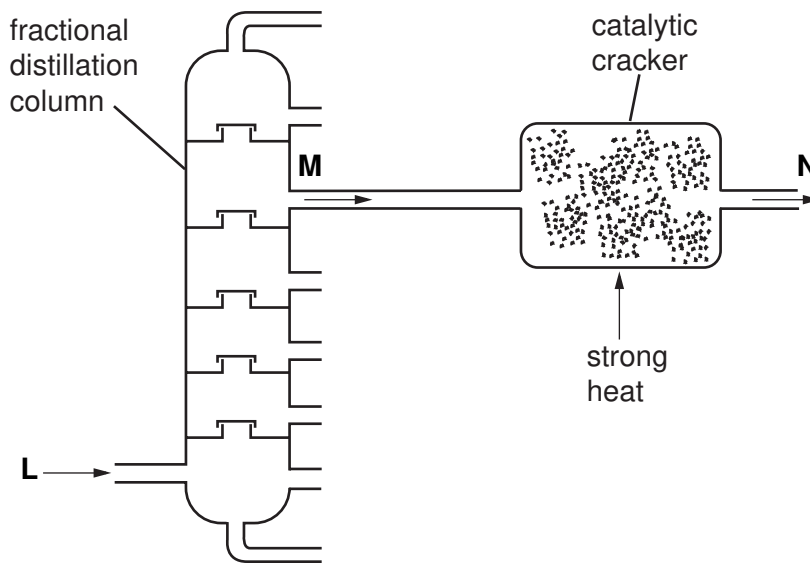

Fig. 5.1

(i) Name the raw material which enters at **L**. ..... [1]

(ii) Describe briefly **two** ways, other than colour and odour, in which the mixture of compounds at **M** differs from the mixture of compounds at **L**.

.....  
 .....  
 ..... [2]

(iii) Describe briefly **two** ways in which the mixture of compounds at **N** differs from the mixture of compounds at **M**.

1 .....  
 2 ..... [2]

- (iv) Some of the compounds in the mixture at **N** can be used in addition polymerisation.

Explain why addition polymers can be made from molecules in the mixture at **N** but not from molecules in the mixture at **M**.

You may draw a diagram if it helps you to answer this question.

.....  
 .....  
 ..... [2]

- (c) A student investigated the combustion products of the liquid fuel ethanol.

He observed that a gas and a colourless liquid were produced.

- (i) The student applied a chemical test to the colourless liquid and found that it was water.

Describe a suitable chemical test for water and its result.

.....  
 .....  
 ..... [2]

- (ii) Complete the equation below for the combustion of ethanol.



6 Fig. 6.1 shows a cube.

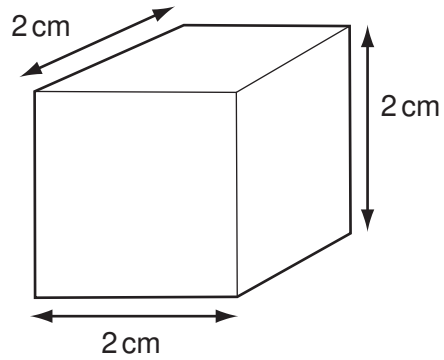

Fig. 6.1

(a) The mass of the cube is 21.6 g.

Calculate the density of the cube.

State the formula that you use and show your working.

formula

working

..... [3]

(b) The solid cube is made up of very small particles. Fig. 6.2 shows their arrangement.

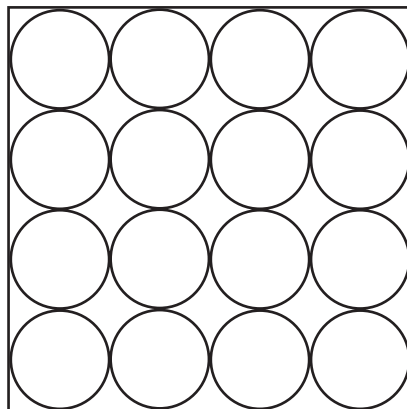
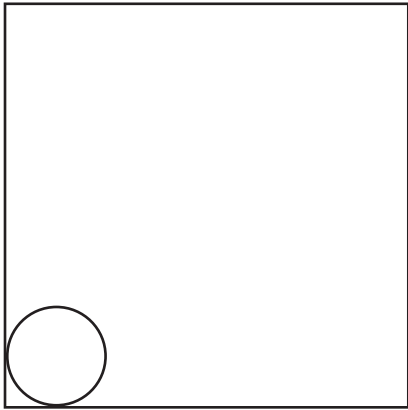
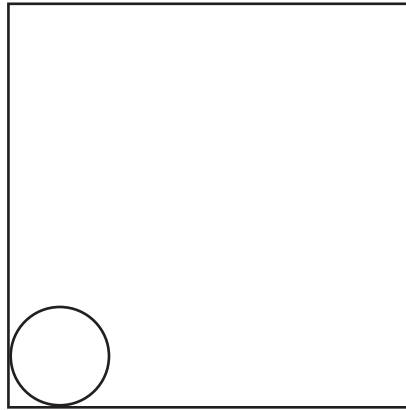

Fig. 6.2

(i) Complete the diagrams below to show the arrangement of particles in a liquid and in a gas.



liquid



gas

[2]

(ii) Explain your answer to (b)(i) in terms of forces between particles.

.....  
.....  
..... [2]

(c) Explain, in terms of particles, why a solid expands when heated.

.....  
.....  
..... [1]

(d) Describe **one** problem caused by a solid metal expanding when it gets hot.

.....  
.....  
..... [2]

7 (a) A student peeled a layer of cells from the inside of an onion bulb. He placed them in a drop of water on a microscope slide and covered them with a coverslip.

Fig. 7.1 shows what he saw when viewing the cells through a microscope.

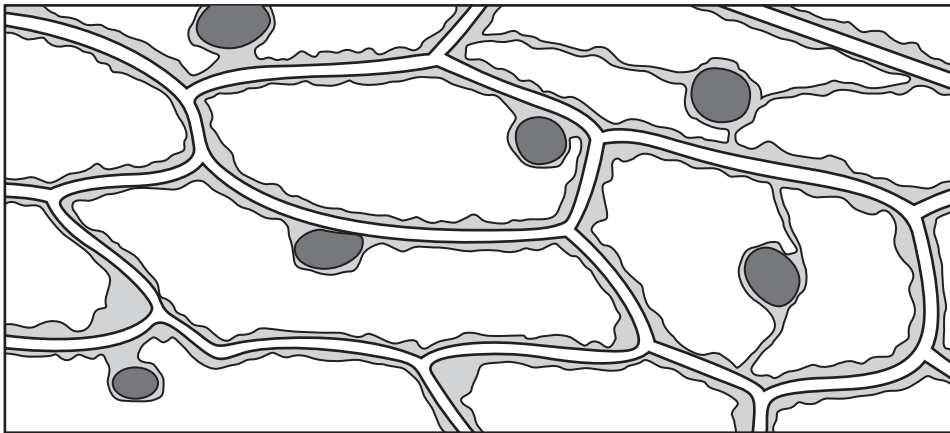

Fig. 7.1

(i) The cells in Fig. 7.1 are similar to each other.

Give the name for a group of similar cells.

.....

[1]

(ii) State **two** ways in which the cells in Fig. 7.1 differ from animal cells.

1 .....

2 ..... [2]

(b) The student replaced the water on the slide with a drop of concentrated sugar solution. He waited for five minutes and then looked at the cells through the microscope again.

Fig. 7.2 shows what he saw.

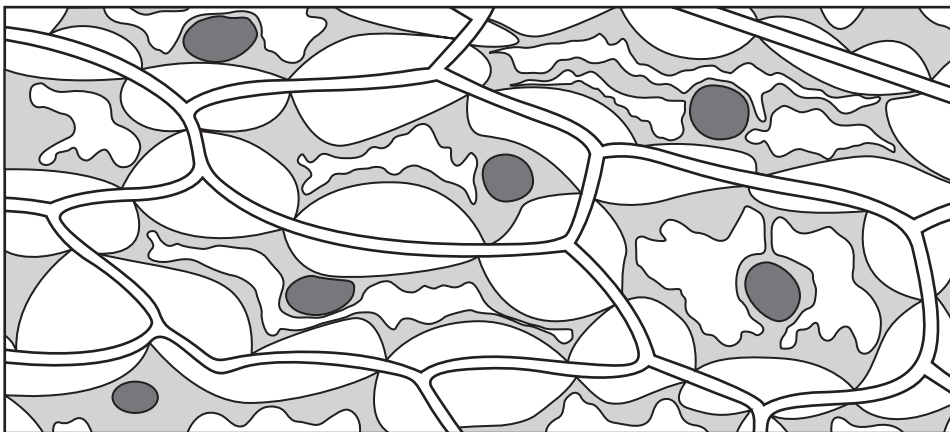

Fig. 7.2

(i) On Fig. 7.2, label a partially permeable membrane. [1]

(ii) Using your knowledge of osmosis, explain what has happened to the cells in Fig. 7.2.

.....  
.....  
.....  
.....  
..... [3]

(c) Onion cells often contain stores of starch. When a person eats an onion, the starch is digested.

Describe how starch is digested in the human alimentary canal.

.....  
.....  
.....  
..... [3]

For  
Examiner's  
Use

- 8 (a) A student used the apparatus in Fig. 8.1 to investigate the rate of a reaction.

For  
Examiner's  
Use

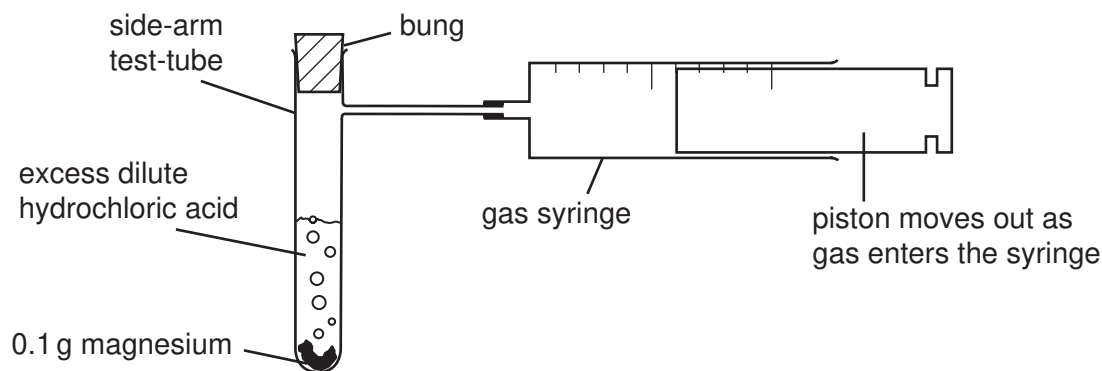

Fig. 8.1

The student dropped the magnesium into the acid contained in the side-arm test-tube and put in the bung. A stopwatch was used to time how long it took for  $50 \text{ cm}^3$  of gas to collect in the syringe.

The student carried out four experiments **A**, **B**, **C** and **D**, and the results are shown in Table 8.1.

Table 8.1

experiment	time for $50 \text{ cm}^3$ of gas to collect in the gas syringe / seconds
<b>A</b>	36
<b>B</b>	18
<b>C</b>	144
<b>D</b>	72

- (i) Explain how the results show that experiment **B** had a higher rate of reaction than experiment **A**.

.....  
 ..... [1]

- (ii) The only variable (factor) which was different between the four experiments **A**, **B**, **C** and **D** was the concentration of the dilute hydrochloric acid.

Using the letters **A**, **B**, **C** and **D**, list the experiments in order of decreasing acid concentration.

..... (highest concentration)

.....

.....

..... (lowest concentration)

[1]



- (iii) Fig. 8.2 shows a piece of magnesium in a beaker of dilute hydrochloric acid. The hydrogen ions, present in all aqueous acids, are shown by the symbol • .

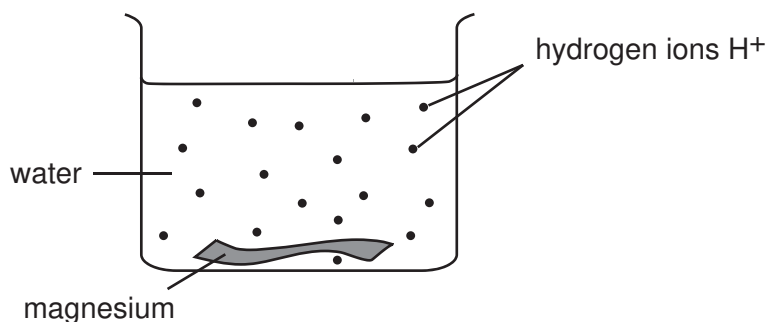

Fig. 8.2

Explain, in terms of ions, why the rate of reaction will change when the concentration of the acid is changed.

.....

.....

.....

.....

.....

..... [3]

- (b) Magnesium reacts with hydrochloric acid to form magnesium chloride and hydrogen gas.

The chemical formula for magnesium chloride is  $\text{MgCl}_2$ . Use the Periodic Table on page 20 to calculate the relative formula mass of magnesium chloride.

Show your working.

..... [2]

For  
Examiner's  
Use

- 9 (a) Fig. 9.1 shows a teacher with a torch (flash light). He switches the torch on and points it at the mirror.

For  
Examiner's  
Use



Fig. 9.1

A ray of light from the torch reflects off the mirror.

Use a ruler to draw a ray of light

- (i) from the torch to the mirror,
- (ii) reflecting off the mirror. [2]

- (b) A torch contains two cells providing a total voltage of 3.0 V across the lamp. When the torch is lit, the current flowing through the lamp is 0.3 A.

- (i) Calculate the resistance of the lamp.

State the formula that you use and show your working.

formula

working

..... [2]

- (ii) To measure the current through the lamp and the voltage across the lamp, the student set up the circuit in Fig. 9.2.

For  
Examiner's  
Use

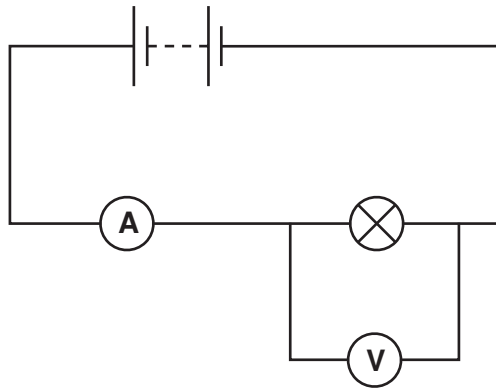

Fig. 9.2

The student sketched a graph of current against voltage for the lamp. This is shown in Fig. 9.3.

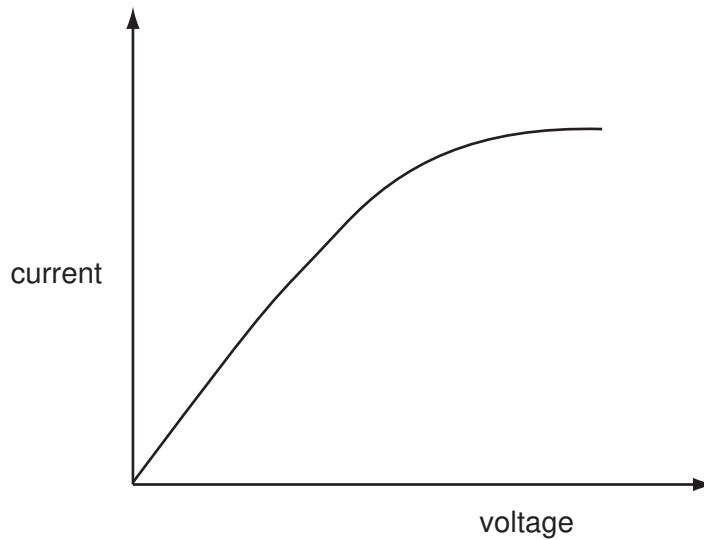

Fig. 9.3

Does the lamp obey Ohms Law?

Explain your answer.

.....  
..... [2]

**DATA SHEET**  
**The Periodic Table of the Elements**

		Group																																		
	I	II	III	IV	V	VI	VII	0																												
	<table style="margin: auto;"> <tr> <td style="text-align: center; border: 1px solid black;">1 <b>H</b> Hydrogen 1</td> <td colspan="11"></td> </tr> </table>										1 <b>H</b> Hydrogen 1																									
1 <b>H</b> Hydrogen 1																																				
3	7 <b>Li</b> Lithium 4	9 <b>Be</b> Beryllium 4																																		
11	23 <b>Na</b> Sodium 12	24 <b>Mg</b> Magnesium 12																																		
19	39 <b>K</b> Potassium 19	40 <b>Ca</b> Calcium 20	45 <b>Sc</b> Scandium 21	48 <b>Ti</b> Titanium 22	51 <b>V</b> Vanadium 23	52 <b>Cr</b> Chromium 24	55 <b>Mn</b> Manganese 25	56 <b>Fe</b> Iron 26	59 <b>Co</b> Cobalt 27	59 <b>Ni</b> Nickel 28	64 <b>Cu</b> Copper 29	65 <b>Zn</b> Zinc 30	70 <b>Ga</b> Gallium 31	73 <b>Ge</b> Germanium 32	75 <b>As</b> Arsenic 33	79 <b>Se</b> Selenium 34	80 <b>Br</b> Bromine 35	84 <b>Kr</b> Krypton 36																		
37	85 <b>Rb</b> Rubidium 37	88 <b>Sr</b> Strontium 38	89 <b>Y</b> Yttrium 39	91 <b>Zr</b> Zirconium 40	93 <b>Nb</b> Niobium 41	96 <b>Mo</b> Molybdenum 42	101 <b>Ru</b> Ruthenium 44	103 <b>Rh</b> Rhodium 45	106 <b>Pd</b> Palladium 46	108 <b>Ag</b> Silver 47	112 <b>Cd</b> Cadmium 48	115 <b>In</b> Indium 49	119 <b>Sn</b> Tin 50	122 <b>Sb</b> Antimony 51	128 <b>Te</b> Tellurium 52	127 <b>I</b> Iodine 53	131 <b>Xe</b> Xenon 54																			
55	133 <b>Cs</b> Caesium 55	137 <b>Ba</b> Barium 56	139 <b>La</b> Lanthanum 57	178 <b>Hf</b> Hafnium 72	181 <b>Ta</b> Tantalum 73	184 <b>W</b> Tungsten 74	190 <b>Os</b> Osmium 76	192 <b>Ir</b> Iridium 77	195 <b>Pt</b> Platinum 78	197 <b>Au</b> Gold 79	201 <b>Hg</b> Mercury 80	204 <b>Tl</b> Thallium 81	207 <b>Pb</b> Lead 82	209 <b>Bi</b> Bismuth 83	210 <b>Po</b> Polonium 84	210 <b>At</b> Astatine 85	210 <b>Rn</b> Radon 86																			
87	226 <b>Fr</b> Francium 87	226 <b>Ra</b> Radium 88	227 <b>Ac</b> Actinium 89																																	
	<table style="margin: auto;"> <tr> <td style="text-align: center; border: 1px solid black;">a</td> <td style="text-align: center; border: 1px solid black;"><b>X</b></td> <td style="text-align: center; border: 1px solid black;">b</td> </tr> </table>										a	<b>X</b>	b																							
a	<b>X</b>	b																																		
	<table style="margin: auto;"> <tr> <td style="text-align: center;">*58-71 Lanthanoid series</td> <td style="text-align: center;">†90-103 Actinoid series</td> </tr> </table>										*58-71 Lanthanoid series	†90-103 Actinoid series																								
*58-71 Lanthanoid series	†90-103 Actinoid series																																			
	<table style="margin: auto;"> <tr> <td style="text-align: center;">140 <b>Ce</b> Cerium 58</td> <td style="text-align: center;">141 <b>Pr</b> Praseodymium 59</td> <td style="text-align: center;">144 <b>Nd</b> Neodymium 60</td> <td style="text-align: center;">150 <b>Sm</b> Samarium 62</td> <td style="text-align: center;">152 <b>Eu</b> Europium 63</td> <td style="text-align: center;">157 <b>Gd</b> Gadolinium 64</td> <td style="text-align: center;">162 <b>Dy</b> Dysprosium 66</td> <td style="text-align: center;">165 <b>Ho</b> Holmium 67</td> <td style="text-align: center;">167 <b>Er</b> Erbium 68</td> <td style="text-align: center;">169 <b>Tm</b> Thulium 69</td> <td style="text-align: center;">173 <b>Yb</b> Ytterbium 70</td> <td style="text-align: center;">175 <b>Lu</b> Lutetium 71</td> </tr> <tr> <td style="text-align: center;">232 <b>Th</b> Thorium 90</td> <td style="text-align: center;">238 <b>Pa</b> Protactinium 91</td> <td style="text-align: center;">238 <b>U</b> Uranium 92</td> <td style="text-align: center;">238 <b>Np</b> Neptunium 93</td> <td style="text-align: center;">238 <b>Pu</b> Plutonium 94</td> <td style="text-align: center;">238 <b>Am</b> Americium 95</td> <td style="text-align: center;">238 <b>Cm</b> Curium 96</td> <td style="text-align: center;">238 <b>Bk</b> Berkelium 97</td> <td style="text-align: center;">238 <b>Cf</b> Californium 98</td> <td style="text-align: center;">238 <b>Es</b> Einsteinium 99</td> <td style="text-align: center;">238 <b>Fm</b> Fermium 100</td> <td style="text-align: center;">238 <b>Md</b> Mendelevium 101</td> <td style="text-align: center;">238 <b>No</b> Nobelium 102</td> <td style="text-align: center;">238 <b>Lr</b> Lawrencium 103</td> </tr> </table>										140 <b>Ce</b> Cerium 58	141 <b>Pr</b> Praseodymium 59	144 <b>Nd</b> Neodymium 60	150 <b>Sm</b> Samarium 62	152 <b>Eu</b> Europium 63	157 <b>Gd</b> Gadolinium 64	162 <b>Dy</b> Dysprosium 66	165 <b>Ho</b> Holmium 67	167 <b>Er</b> Erbium 68	169 <b>Tm</b> Thulium 69	173 <b>Yb</b> Ytterbium 70	175 <b>Lu</b> Lutetium 71	232 <b>Th</b> Thorium 90	238 <b>Pa</b> Protactinium 91	238 <b>U</b> Uranium 92	238 <b>Np</b> Neptunium 93	238 <b>Pu</b> Plutonium 94	238 <b>Am</b> Americium 95	238 <b>Cm</b> Curium 96	238 <b>Bk</b> Berkelium 97	238 <b>Cf</b> Californium 98	238 <b>Es</b> Einsteinium 99	238 <b>Fm</b> Fermium 100	238 <b>Md</b> Mendelevium 101	238 <b>No</b> Nobelium 102	238 <b>Lr</b> Lawrencium 103
140 <b>Ce</b> Cerium 58	141 <b>Pr</b> Praseodymium 59	144 <b>Nd</b> Neodymium 60	150 <b>Sm</b> Samarium 62	152 <b>Eu</b> Europium 63	157 <b>Gd</b> Gadolinium 64	162 <b>Dy</b> Dysprosium 66	165 <b>Ho</b> Holmium 67	167 <b>Er</b> Erbium 68	169 <b>Tm</b> Thulium 69	173 <b>Yb</b> Ytterbium 70	175 <b>Lu</b> Lutetium 71																									
232 <b>Th</b> Thorium 90	238 <b>Pa</b> Protactinium 91	238 <b>U</b> Uranium 92	238 <b>Np</b> Neptunium 93	238 <b>Pu</b> Plutonium 94	238 <b>Am</b> Americium 95	238 <b>Cm</b> Curium 96	238 <b>Bk</b> Berkelium 97	238 <b>Cf</b> Californium 98	238 <b>Es</b> Einsteinium 99	238 <b>Fm</b> Fermium 100	238 <b>Md</b> Mendelevium 101	238 <b>No</b> Nobelium 102	238 <b>Lr</b> Lawrencium 103																							
	<p>a = relative atomic mass X = atomic symbol b = proton (atomic) number</p>																																			

The volume of one mole of any gas is 24 dm<sup>3</sup> at room temperature and pressure (r.t.p.).

Permission to reproduce items where third-party owned material protected by copyright is included has been sought and cleared where possible. Every reasonable effort has been made by the publisher (UCLES) to trace copyright holders, but if any items requiring clearance have unwittingly been included, the publisher will be pleased to make amends at the earliest possible opportunity.

University of Cambridge International Examinations is part of the Cambridge Assessment Group. Cambridge Assessment is the brand name of University of Cambridge Local Examinations Syndicate (UCLES), which is itself a department of the University of Cambridge.