



COMBINED SCIENCE

0653/21

Paper 2 Multiple Choice (Extended)

October/November 2018

45 minutes

Additional Materials: Multiple Choice Answer Sheet
Soft clean eraser
Soft pencil (type B or HB is recommended)



READ THESE INSTRUCTIONS FIRST

Write in soft pencil.

Do not use staples, paper clips, glue or correction fluid.

Write your name, Centre number and candidate number on the Answer Sheet in the spaces provided unless this has been done for you.

DO NOT WRITE IN ANY BARCODES.

There are **forty** questions on this paper. Answer **all** questions. For each question there are four possible answers **A, B, C** and **D**.

Choose the **one** you consider correct and record your choice in **soft pencil** on the separate Answer Sheet.

Read the instructions on the Answer Sheet very carefully.

Each correct answer will score one mark. A mark will not be deducted for a wrong answer.

Any rough working should be done in this booklet.

A copy of the Periodic Table is printed on page 16.

Electronic calculators may be used.

This document consists of **14** printed pages and **2** blank pages.

1 Which structure found in plant cells is matched to its function?

	structure	function
A	cell membrane	provides strength and support
B	chloroplast	absorbs light energy
C	cytoplasm	filled with cell sap for strengthening
D	permanent vacuole	site of chemical reactions

2 Which process depends on diffusion?

- A** circulation
- B** digestion
- C** gaseous exchange
- D** phagocytosis

3 Biological catalysts speed up reactions in the body.

What is another name for biological catalysts?

- A** antibodies
- B** enzymes
- C** fatty acids
- D** hormones

4 Microorganisms are used to make yoghurt.

Which acid is produced when microorganisms break down lactose in the milk?

- A** amino acid
- B** fatty acid
- C** hydrochloric acid
- D** lactic acid

- 5 The diagram shows a leaf that was tested for starch using iodine solution.

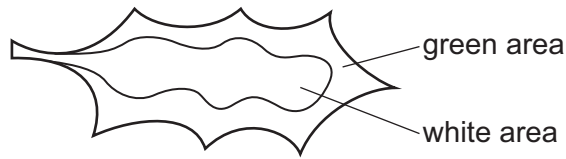

Which row shows the results for this leaf and explains the results?

	green area of leaf after test	white area of leaf after test	explanation
A	blue-black	blue-black	chlorophyll is found in all parts of the leaf
B	blue-black	brown	chlorophyll is found in only part of the leaf
C	brown	brown	chlorophyll is found in all parts of the leaf
D	brown	blue-black	chlorophyll is found in only part of the leaf

- 6 The diagram shows part of the human alimentary canal.

Where is bile made?

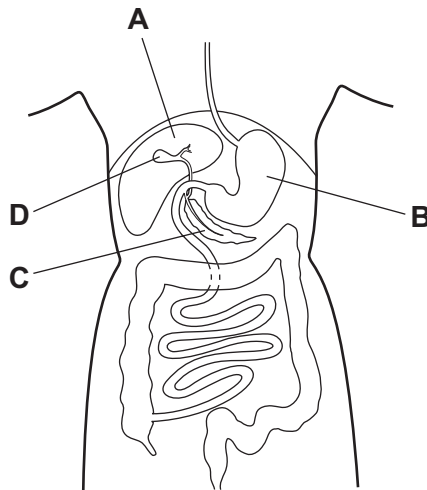

7 Which diagram shows the double circulatory system of a human?

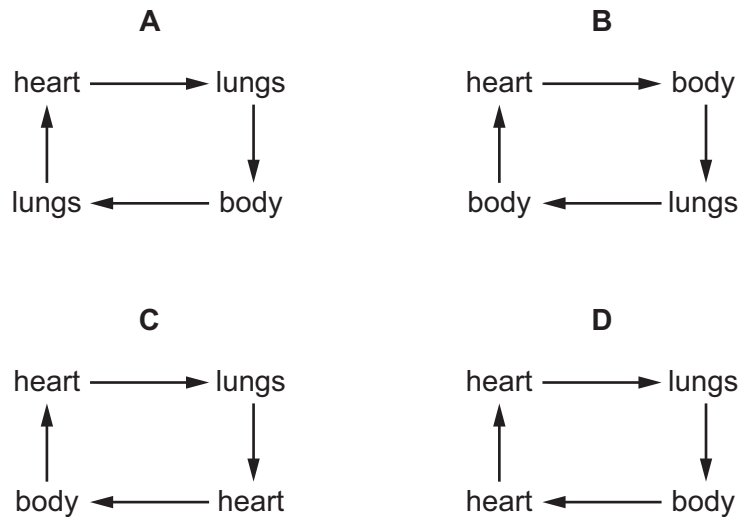

8 Aerobic respiration is the release of a relativelyX..... amount of energy by the breakdown of food substances in the presence ofY..... .

Which words complete the gaps X and Y?

	X	Y
A	large	carbon dioxide
B	large	oxygen
C	small	carbon dioxide
D	small	oxygen

9 The diagram shows structures called lamellae. They are found in the gills of fish.

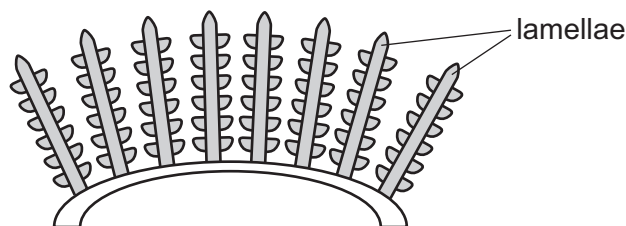

Lamellae increase the surface area of the gills. The gills are the site of gaseous exchange in fish.

What is the effect of this increased surface area?

- A** decreased rate of carbon dioxide diffusion into the blood
- B** decreased rate of oxygen diffusion into the blood
- C** increased rate of carbon dioxide diffusion into the blood
- D** increased rate of oxygen diffusion into the blood

10 Which statement about adrenaline is **not** correct?

- A Adrenaline is transported in the blood plasma.
- B Adrenaline lowers the blood glucose concentration.
- C The heart is one of the target organs for adrenaline.
- D The liver destroys adrenaline.

11 What is the function of the amniotic sac?

- A It surrounds the fetus in the uterus and contains amniotic fluid.
- B It surrounds the fetus in the uterus and provides essential nutrients for the fetus.
- C It surrounds the fetus in the vagina and contains amniotic fluid.
- D It surrounds the fetus in the vagina and provides essential nutrients for the fetus.

12 What is the definition of a trophic level?

- A It shows how an organism loses energy.
- B It shows the position of an organism in a food chain.
- C It shows the consumers of an organism.
- D It shows the food eaten by an organism.

13 Which are possible harmful effects of deforestation?

	global warming	species extinction
A	✓	✓
B	✓	x
C	x	✓
D	x	x

14 Sucrose is a covalent compound.

It is a solid at room temperature.

Which statement about sucrose is correct?

- A It is made of atoms that are close together and in continuous random motion.
- B It is made of atoms that are far apart and vibrating about a fixed point.
- C It is made of molecules that are close together and vibrating about a fixed point.
- D It is made of molecules that are far apart and in continuous random motion.

15 Four dyes are separated using chromatography.

The results are shown.

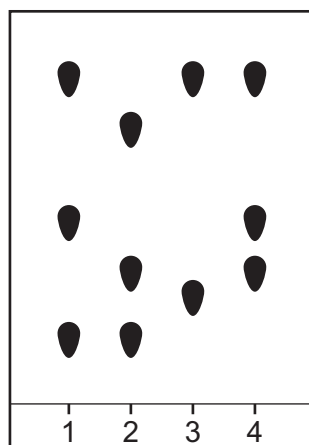

Which dyes contain two colours that are present in both dyes?

- A 1 and 2 B 1 and 4 C 2 and 3 D 2 and 4

16 Which diagram represents the bonding in a molecule of ethene?

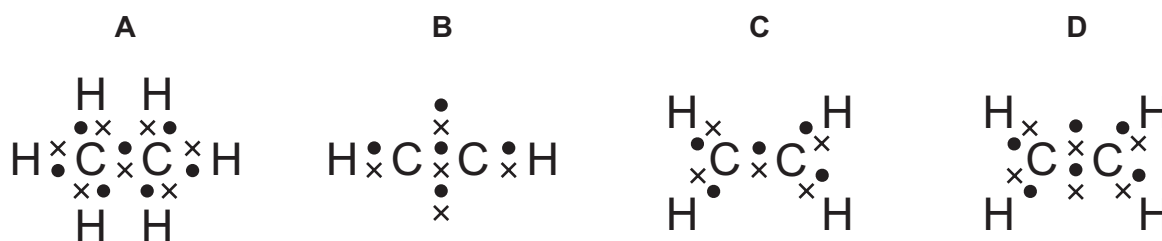

17 On which label does the formula match the name of the acid?

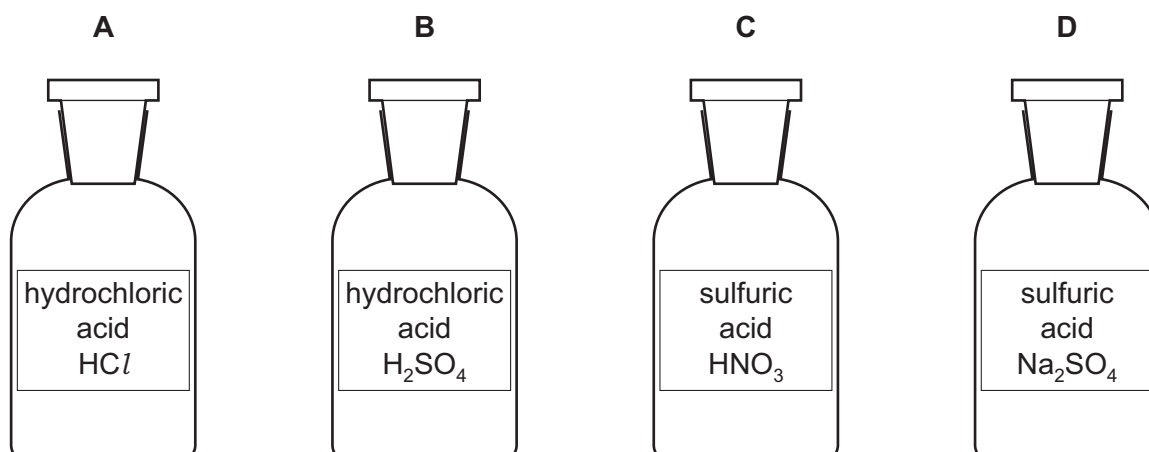

18 Some chemical compounds are broken down by electrolysis using inert electrodes.

Which row identifies the electrode products for the stated electrolyte?

	electrolyte	product at anode	product at cathode
A	aqueous copper chloride	hydrogen	copper
B	molten aluminium oxide	aluminium	oxygen
C	molten copper chloride	chlorine	copper
D	molten potassium bromide	potassium	bromine

19 When concentrated sulfuric acid is added to water, the temperature of the mixture increases.

Which row describes the type of reaction and the energy change for this process?

	type of reaction	energy change
A	endothermic	chemical to thermal
B	endothermic	thermal to chemical
C	exothermic	chemical to thermal
D	exothermic	thermal to chemical

20 Which diagram shows apparatus used to investigate the rate of a reaction in which a gas is given off?

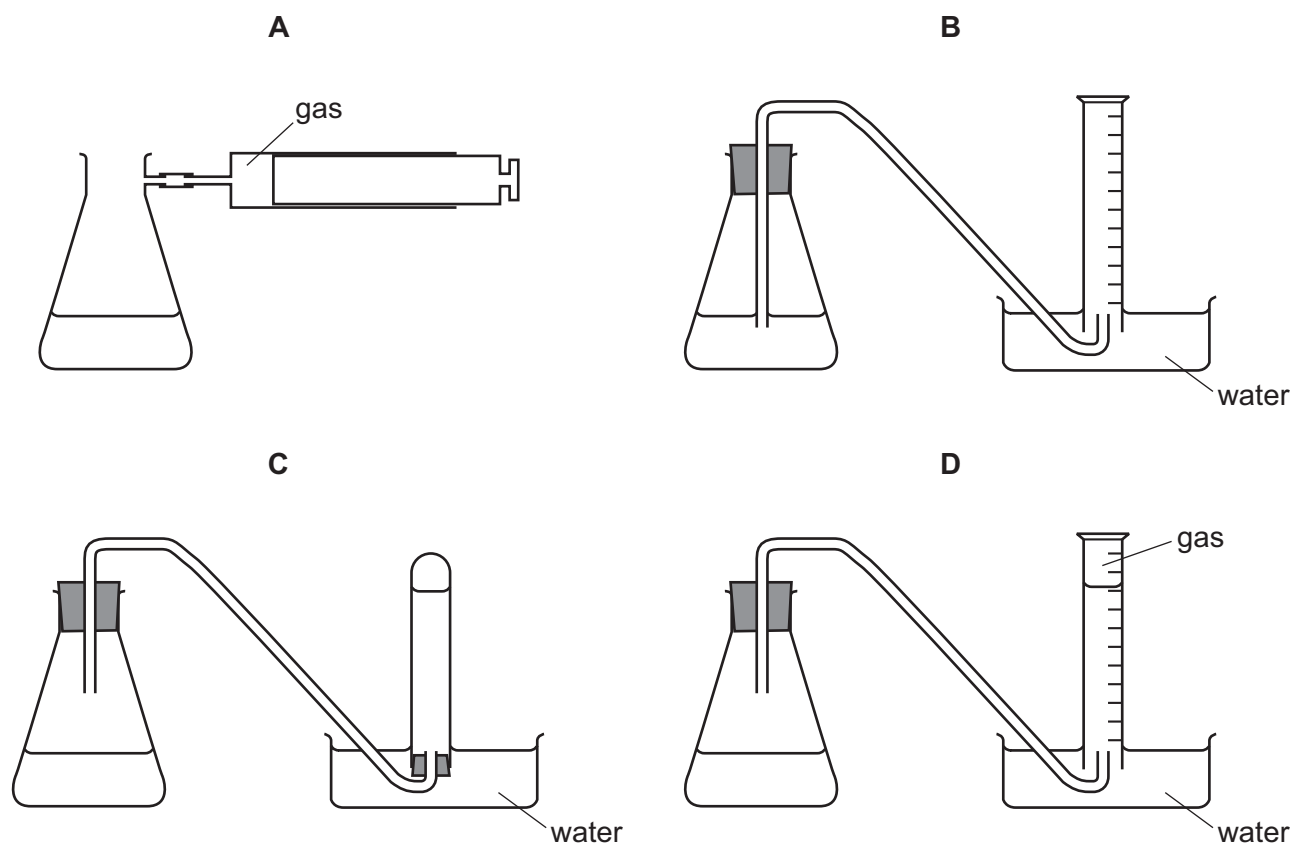

21 Iron oxide reacts with carbon monoxide.

The word equation for the reaction is:



Which statement is **not** correct?

- A Carbon is neither oxidised nor reduced.
 - B Carbon is oxidised.
 - C Iron is reduced.
 - D This is a redox reaction.
- 22 Which element in a period of the Periodic Table has the greatest metallic character?
- A the element which most readily forms an anion
 - B the element with the fewest outer-shell electrons
 - C the element with the highest atomic number
 - D the element with the largest group number
- 23 The positions of four elements are shown in the outline of the Periodic Table.

Which element has a high melting point and forms coloured compounds?

												A							B
C	D																		

24 Which gas is used to provide an inert atmosphere in lamps?

- A argon
- B helium
- C neon
- D nitrogen

25 Which statement about metals is **not** correct?

- A Copper is below hydrogen in the reactivity series.
- B Lithium produces a flame when a small piece is added to cold water.
- C Magnesium reacts with steam to produce hydrogen.
- D Zinc reacts with copper ions to form zinc ions and copper.

26 Gasoline is a hydrocarbon fuel obtained from petroleum.

Which statement is correct?

- A Gasoline burns to form carbon dioxide and water.
- B Gasoline contains the elements carbon, hydrogen and oxygen.
- C Gasoline is used as a fuel in diesel engines.
- D The combustion of gasoline is an endothermic reaction.

27 P, Q and R are three fractions obtained from petroleum by fractional distillation.

Molecules of R are larger than molecules of P.

The intermolecular forces in Q are weaker than those in P.

What is the order of boiling points?

	lowest	→	highest
A	P	Q	R
B	Q	P	R
C	R	P	Q
D	R	Q	P

28 A gold block is taken from the surface of the Earth to the surface of the Moon.

The gravitational field is weaker on the Moon than it is on the Earth.

Which property of the gold block changes?

- A density
- B mass
- C volume
- D weight

- 29 A cube of aluminium has sides of length 1.0 cm.

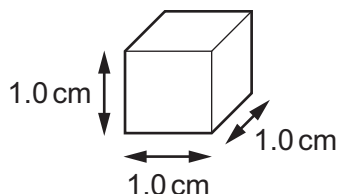

Compared with this cube, which statement about a cube of aluminium with sides of 2.0 cm is correct?

- A It has the same density.
 B It has the same mass.
 C It has twice the density.
 D It has twice the mass.
- 30 A spring that obeys Hooke's law is 20 cm long when unstretched.

A load of 10 N is hung from the spring and its length increases to 25 cm.

The 10 N load is removed and replaced with a 30 N load.

What is the new length of the spring?

- A 15 cm B 35 cm C 40 cm D 60 cm
- 31 A brick of mass 4.0 kg rests on a window ledge. It falls off the window ledge and drops through a height of 5.0 m to the ground. The acceleration of free fall g is 10 m/s^2 .

Air resistance can be ignored.

Which row states the kinetic energy and the speed of the brick just before it hits the ground?

	kinetic energy of brick/J	<u>speed of brick</u> m/s
A	20	2.2
B	20	3.2
C	200	7.1
D	200	10

32 A scientist investigates two different substances, P and Q.

Substance P completely fills its container but can be compressed.

Substance Q is not in a container but has a definite shape.

In which state is each substance?

	substance P	substance Q
A	gas	liquid
B	gas	solid
C	liquid	gas
D	liquid	solid

33 A liquid evaporates when molecules leave its surface.

Which molecules leave the surface, and what happens to the temperature of the remaining liquid?

- A** The more energetic molecules leave and the temperature falls.
- B** The more energetic molecules leave and the temperature rises.
- C** The less energetic molecules leave and the temperature falls.
- D** The less energetic molecules leave and the temperature rises.

34 How is heat transferred in solids?

- A** Heated molecules become less dense and travel to colder areas.
- B** Heated molecules become more dense and travel to colder areas.
- C** Heated molecules vibrate more quickly and cause neighbouring molecules to vibrate more quickly.
- D** Heated molecules vibrate more slowly and cause neighbouring molecules to vibrate more quickly.

- 35 The diagram shows a water wave travelling at 0.56 m/s.

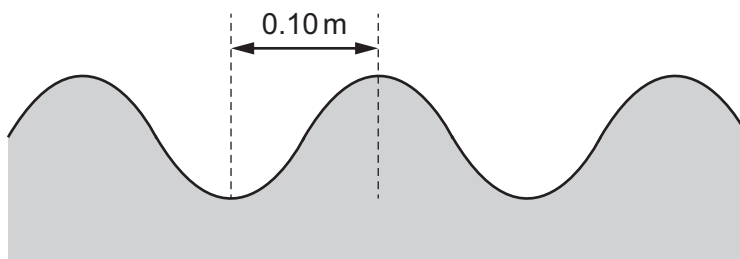

What is the frequency of the wave?

- A** 0.11 Hz **B** 0.36 Hz **C** 2.8 Hz **D** 5.6 Hz
- 36 Which list shows electromagnetic waves in order of decreasing wavelength (largest to smallest)?
- A** gamma rays → radio waves → infra-red → microwaves
B microwaves → visible light → X-rays → infra-red
C radio waves → visible light → ultraviolet → X-rays
D X-rays → infra-red → microwaves → visible light
- 37 The diagrams represent four different sound waves. The scales are the same in all the diagrams.

Which sound has the lowest pitch?

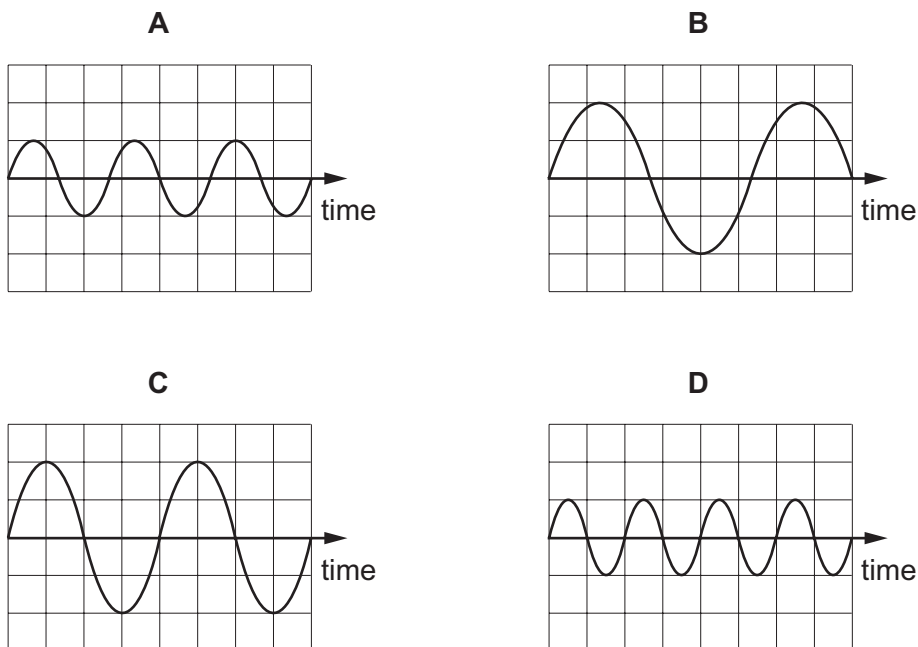

- 38 The diagram shows a negatively charged oil drop between two metal plates. The plates are connected by an open switch to a power supply. The oil drop is falling at a steady speed.

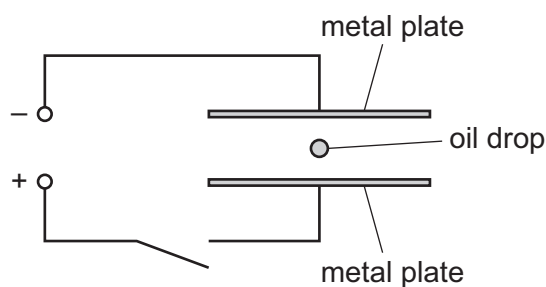

The switch is now closed.

What happens to the oil drop?

- A** It moves downwards at an increasing speed.
B It moves upwards at an increasing speed.
C It moves to the left at a constant speed.
D It moves to the right at a constant speed.
- 39 Three pieces of resistance wire X, Y and Z are made of the same metal.

The diagram shows the lengths and the diameters of the wires.

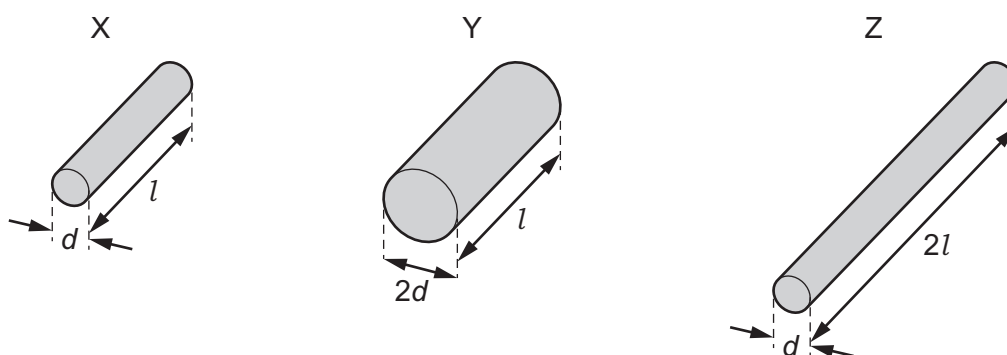

What is the order of the wires when they are placed in order of increasing resistance, least resistance first?

- A** $Y \rightarrow X \rightarrow Z$ **B** $Y \rightarrow Z \rightarrow X$ **C** $Z \rightarrow X \rightarrow Y$ **D** $Z \rightarrow Y \rightarrow X$
- 40 An electric motor is connected to a 120 V mains supply.

The motor transfers 72 000 J of energy in 2.0 minutes.

What is the current in the motor?

- A** 0.20 A **B** 5.0 A **C** 10 A **D** 300 A

BLANK PAGE

Permission to reproduce items where third-party owned material protected by copyright is included has been sought and cleared where possible. Every reasonable effort has been made by the publisher (UCLES) to trace copyright holders, but if any items requiring clearance have unwittingly been included, the publisher will be pleased to make amends at the earliest possible opportunity.

To avoid the issue of disclosure of answer-related information to candidates, all copyright acknowledgements are reproduced online in the Cambridge International Examinations Copyright Acknowledgements Booklet. This is produced for each series of examinations and is freely available to download at www.cie.org.uk after the live examination series.

Cambridge International Examinations is part of the Cambridge Assessment Group. Cambridge Assessment is the brand name of University of Cambridge Local Examinations Syndicate (UCLES), which is itself a department of the University of Cambridge.

The Periodic Table of Elements

		Group															
I	II	III	IV	V	VI	VII	VIII										
3 Li lithium 7	4 Be beryllium 9	<div style="border: 1px solid black; padding: 5px; width: fit-content; margin: 0 auto;"> Key atomic number atomic symbol name relative atomic mass </div>										2 He helium 4					
11 Na sodium 23	12 Mg magnesium 24											5 B boron 11	6 C carbon 12	7 N nitrogen 14	8 O oxygen 16	9 F fluorine 19	10 Ne neon 20
19 K potassium 39	20 Ca calcium 40	21 Sc scandium 45	22 Ti titanium 48	23 V vanadium 51	24 Cr chromium 52	25 Mn manganese 55	26 Fe iron 56	27 Co cobalt 59	28 Ni nickel 59	29 Cu copper 64	30 Zn zinc 65	31 Ga gallium 70	32 Ge germanium 73	33 As arsenic 75	34 Se selenium 79	35 Br bromine 80	36 Kr krypton 84
37 Rb rubidium 85	38 Sr strontium 88	39 Y yttrium 89	40 Zr zirconium 91	41 Nb niobium 93	42 Mo molybdenum 96	43 Tc technetium —	44 Ru ruthenium 101	45 Rh rhodium 103	46 Pd palladium 106	47 Ag silver 108	48 Cd cadmium 112	49 In indium 115	50 Sn tin 119	51 Sb antimony 122	52 Te tellurium 128	53 I iodine 127	54 Xe xenon 131
55 Cs caesium 133	56 Ba barium 137	57–71 lanthanoids	72 Hf hafnium 178	73 Ta tantalum 181	74 W tungsten 184	75 Re rhenium 186	76 Os osmium 190	77 Ir iridium 192	78 Pt platinum 195	79 Au gold 197	80 Hg mercury 201	81 Tl thallium 204	82 Pb lead 207	83 Bi bismuth 209	84 Po polonium —	85 At astatine —	86 Rn radon —
87 Fr francium —	88 Ra radium —	89–103 actinoids	104 Rf rutherfordium —	105 Db dubnium —	106 Sg seaborgium —	107 Bh bohrium —	108 Hs hassium —	109 Mt meitnerium —	110 Ds darmstadtium —	111 Rg roentgenium —	112 Cn copernicium —	114 Fl flerovium —	116 Lv livermorium —	—	—	—	—

lanthanoids	57 La lanthanum 139	58 Ce cerium 140	59 Pr praseodymium 141	60 Nd neodymium 144	61 Pm promethium —	62 Sm samarium 150	63 Eu europium 152	64 Gd gadolinium 157	65 Tb terbium 159	66 Dy dysprosium 163	67 Ho holmium 165	68 Er erbium 167	69 Tm thulium 169	70 Yb ytterbium 173	71 Lu lutetium 175
actinoids	89 Ac actinium —	90 Th thorium 232	91 Pa protactinium 231	92 U uranium 238	93 Np neptunium —	94 Pu plutonium —	95 Am americium —	96 Cm curium —	97 Bk berkelium —	98 Cf californium —	99 Es einsteinium —	100 Fm fermium —	101 Md mendelevium —	102 No nobelium —	103 Lr lawrencium —

The volume of one mole of any gas is 24 dm³ at room temperature and pressure (r.t.p.).