



Cambridge IGCSE™ (9–1)

CANDIDATE
NAME

CENTRE
NUMBER

--	--	--	--	--

CANDIDATE
NUMBER

--	--	--	--

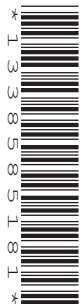

CO-ORDINATED SCIENCES

0973/62

Paper 6 Alternative to Practical

May/June 2020

1 hour 30 minutes

You must answer on the question paper.

No additional materials are needed.

INSTRUCTIONS

- Answer **all** questions.
- Use a black or dark blue pen. You may use an HB pencil for any diagrams or graphs.
- Write your name, centre number and candidate number in the boxes at the top of the page.
- Write your answer to each question in the space provided.
- Do **not** use an erasable pen or correction fluid.
- Do **not** write on any bar codes.
- You may use a calculator.
- You should show all your working and use appropriate units.

INFORMATION

- The total mark for this paper is 60.
- The number of marks for each question or part question is shown in brackets [].

This document has **20** pages. Blank pages are indicated.

- 1 A student investigates an enzyme used in the extraction of apple juice.

Procedure

- He adds enzyme solution to a beaker containing some apple puree.
 - He places this beaker in a water-bath at 35 °C for five minutes.
 - He filters the puree and collects the juice in a measuring cylinder.
 - He measures and records in Table 1.1 the total volume of juice collected every 2 minutes for 10 minutes.
- (a) Draw a labelled diagram of the apparatus he uses to filter and collect the juice from the apple puree.

(b) Fig. 1.1 shows the volume of juice collected after 6 minutes.

Read and record this value in Table 1.1.

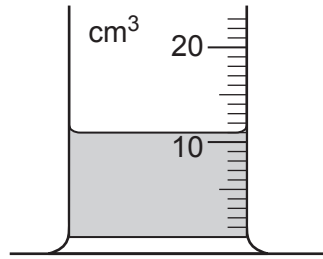

Fig. 1.1

Table 1.1

time / minutes	volume of juice collected / cm^3
0	0
2	6
4	9
6	
8	12
10	12

[1]

(c) (i) On the grid provided, plot a graph of volume of juice collected (vertical axis) against time.

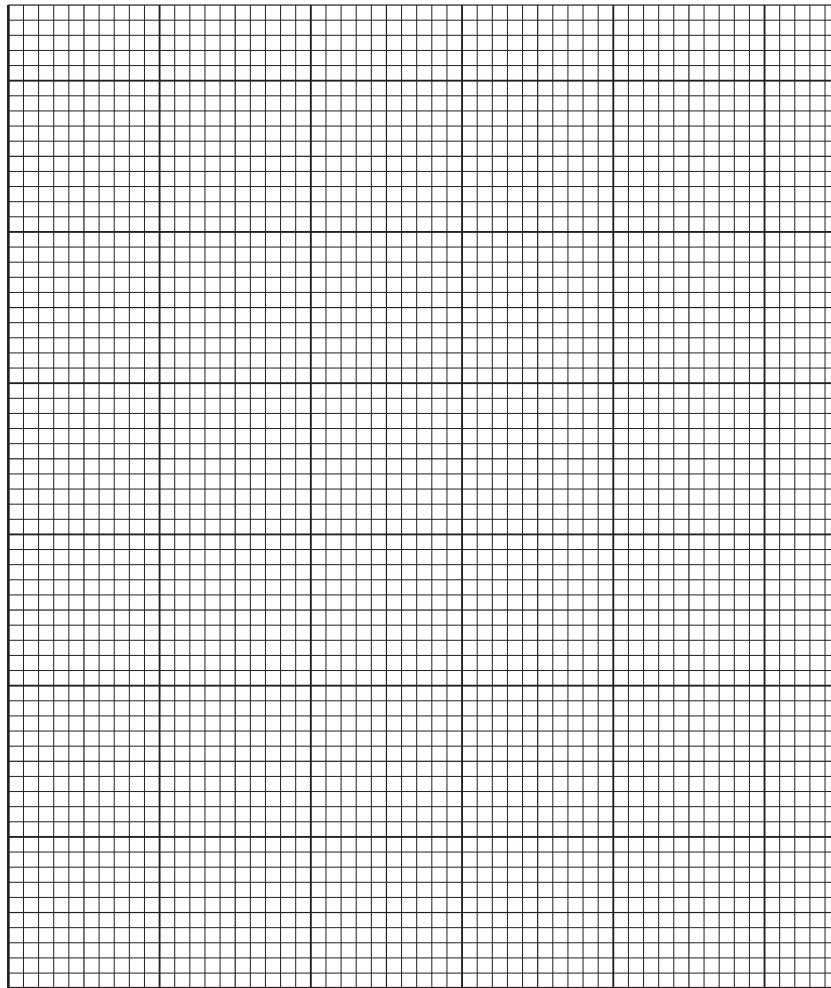

[3]

(ii) Draw the best-fit curve.

[1]

(d) Use your graph to estimate the total volume of juice collected at 3 minutes.

Show on your graph how you arrived at your answer.

total volume of juice collected at 3 minutes [2]

(e) A student does several experiments to determine the optimum temperature for juice extraction using an enzyme.

Suggest temperatures that the student should use.

.....
..... [2]

[Total: 12]

- 2 A student investigates the nutrient content of apple puree and the nutrient content of bread using Benedict's solution, biuret solution and iodine solution.

The apple puree tests positive with the Benedict's solution and negative with the biuret solution.

The bread tests positive with both the biuret solution and iodine solution.

- (a) Record in Table 2.1 the final colours the student observes.

Table 2.1

food sample	final colour observed with Benedict's solution	final colour observed with biuret solution	final colour observed with iodine solution
apple puree			
bread			

[4]

- (b) Use Table 2.1 to state the nutrient content of the apple puree and the nutrient content of the bread.

apple puree contains

bread contains

[2]

- (c) (i) A student tests the apple puree and bread for the presence of fat.

State the two substances he needs to use to test for fat.

..... and [1]

- (ii) State the observation for a positive result.

..... [1]

[Total: 8]

3 In this investigation a student is going to identify four solutions, **J**, **K**, **L** and **M**.

The names of the solutions are shown.

aqueous ammonia

acidified aqueous barium nitrate

aqueous copper sulfate

aqueous sodium hydroxide

The student does three experiments to identify which of these solutions are solutions **J**, **K**, **L** and **M**.

The results are shown in Table 3.1.

Table 3.1

experiment	method	observations
1	The student adds a small volume of K to a sample of J .	white ppt. in a blue solution
2	The student adds L slowly drop by drop to J until there is no further change.	light blue ppt. insoluble in excess
3	The student adds M slowly drop by drop to J until there is no further change.	light blue ppt. soluble in excess giving a dark blue solution

(a) **J** is a blue solution.

All the other solutions are colourless.

(i) Name solution **J**.

..... [1]

(ii) Use the observations from experiment 1 to name **K**.

K [1]

(iii) Use the observations from experiments 2 and 3 to name solutions L and M.

Explain how you arrived at your answer.

L

M

explanation

.....

.....

.....

[2]

(b) Fig. 3.1 shows the pH colour chart for universal indicator solution.

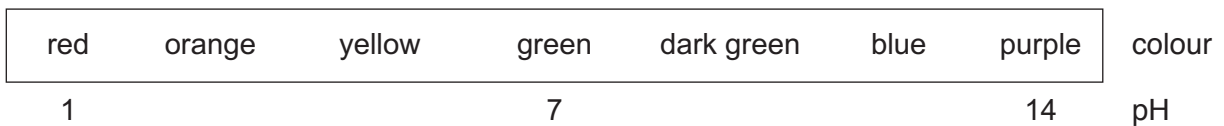

Fig. 3.1

(i) The student adds a few drops of universal indicator solution to a sample of aqueous sodium hydroxide.

Predict the colour you would expect to see.

..... [1]

(ii) The student adds a few drops of universal indicator solution to a sample of J.

Explain why it is difficult to determine the pH of J using universal indicator solution.

.....

..... [1]

[Total: 6]

- 4 A student investigates the amount of thermal energy (heat) absorbed when solid ammonium chloride dissolves in water.

The student:

- adds 25 cm³ of distilled water to a 100 cm³ glass beaker
- measures and records the temperature of the water
- adds a sample of ammonium chloride to the water
- stirs the mixture and records the lowest temperature reached.

- (a) Fig. 4.1 shows the temperature of the water at the start and the lowest temperature reached by the mixture.

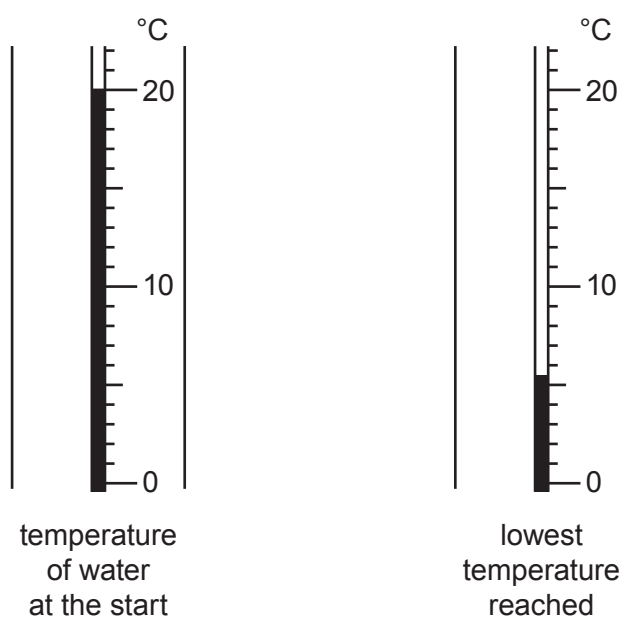

Fig. 4.1

Record these temperatures to the nearest 0.5 °C.

temperature of water at start = °C

lowest temperature reached = °C
[2]

- (b) Calculate the maximum temperature change, ΔT .

$\Delta T = \dots\dots\dots$ °C [1]

(c) Calculate the thermal energy, E , absorbed when ammonium chloride dissolves in water.

Use the equation shown.

$$E = 105 \times \Delta T$$

$$E = \dots\dots\dots \text{ J [1]}$$

(d) The temperature does not decrease as much as it should.

This is because the water gains thermal energy from the surroundings.

Suggest two changes to the apparatus that will reduce the amount of thermal energy gained from the surroundings.

1

2

[2]

(e) Explain why this experiment should be repeated several times and an average for the temperature change calculated.

.....
..... [1]

[Total: 7]

BLANK PAGE

- 6 A student determines the focal length f of a lens by measuring the magnification of the image that it forms on a screen.

She sets up the apparatus as shown in Fig. 6.1.

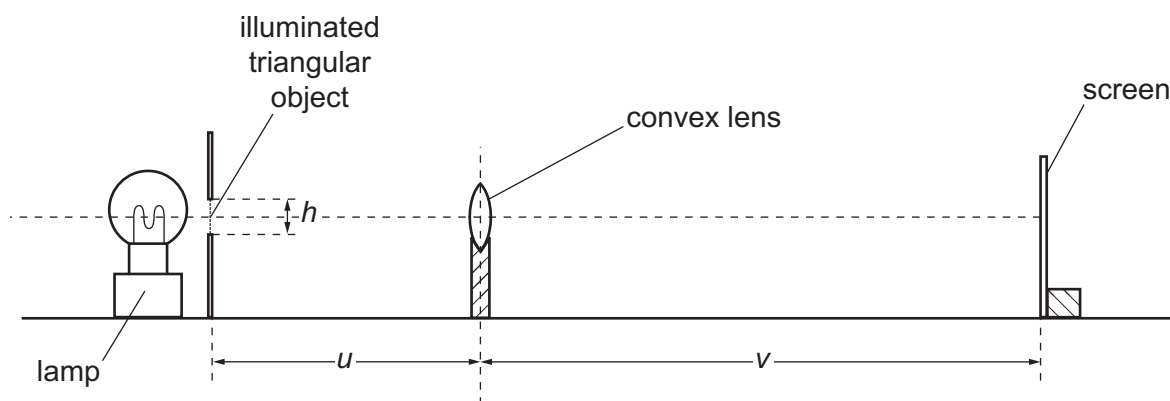

Fig. 6.1

- (a) Fig. 6.2 shows a full size diagram of the illuminated triangular object.

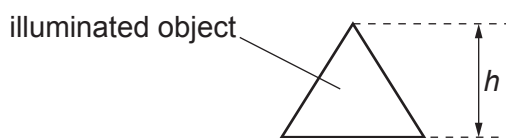

Fig. 6.2

Measure the height h of the illuminated triangular object to the nearest 0.1 cm.

$h = \dots\dots\dots$ cm [1]

(b) Procedure

- The student switches on the lamp.
- She places the lens at a distance $u = 20.0$ cm from the illuminated triangular object.
- She adjusts the position of the screen by moving it slowly backwards and forwards until a sharp triangular image is formed on the screen.
- She uses a metre rule placed on the bench to measure the image distance v .

Fig. 6.3 shows the position of the screen when she takes her measurement.

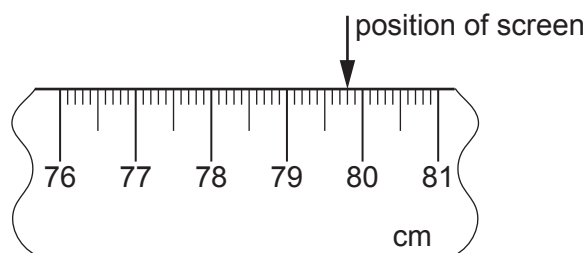

Fig. 6.3

- (i) Record the reading on the rule at the position of the screen.

reading on rule = $\dots\dots\dots$ cm [1]

(ii) The centre of the lens is at the 20.0 cm mark on the rule.

Calculate the image distance v and record its value in Table 6.1.

Table 6.1

u /cm	v /cm	H /cm	m	f /cm
20.0				
40.0	24.3	0.9		

[1]

(iii) Fig. 6.4 shows a full size diagram of the image.

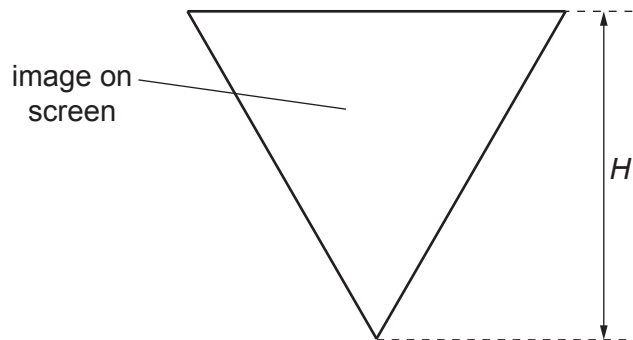

Fig. 6.4

Measure and record in Table 6.1 the height H of the image to the nearest 0.1 cm. [1]

(iv) State one difference between the object and its image.

..... [1]

- (c) The student repeats the procedure in (b) for an object distance $u = 40.0$ cm.

Her results are shown in Table 6.1.

Use your answer to (a) and the values of H in Table 6.1 to calculate the magnifications m of the images. Use the equation shown.

$$m = \frac{\text{height of image } H}{\text{height of object } h}$$

Record your answers in Table 6.1.

[1]

- (d) The focal length f can be calculated using the equation shown.

$$f = \frac{v}{(1 + m)}$$

Use the equation to calculate both values of f . Record your answers in Table 6.1.

Give your answers to **three** significant figures.

[2]

- (e) State whether the values of f in Table 6.1 are the same, within the limits of experimental error.

Justify your answer with reference to the values of f .

.....
 [1]

- (f) State one precaution that the student takes in this experiment to obtain accurate results.

.....
 [1]

[Total: 10]

7 A student determines the thermal energy lost from a beaker of water when hot and cold water are mixed.

She pours 100 cm³ of cold water into a beaker.

(a) (i) Suggest a suitable piece of apparatus she can use to measure 100 cm³ of water.

..... [1]

(ii) Fig. 7.1 shows part of the scale of a thermometer.

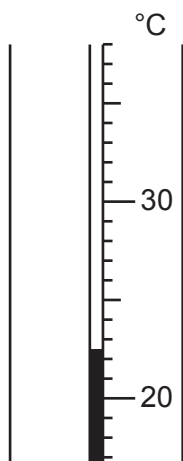

Fig. 7.1

Read the thermometer scale and record to the nearest 0.5 °C the temperature θ_C of the cold water.

$\theta_C = \dots\dots\dots$ °C [1]

(b) Procedure

- She pours 100 cm³ of hot water into a second beaker.
- She measures and records the temperature θ_H of the hot water.

$\theta_H = 79.5^\circ\text{C}$

- Immediately, she pours the cold water from the first beaker into the beaker of hot water.
- She stirs the mixture.
- She measures and records the highest temperature θ_M of the mixture.

$\theta_M = 46.0^\circ\text{C}$

(i) Explain why the water is stirred before measuring the temperature of the mixture.

.....
 [1]

- (ii) When performing experiments using hot water, there is always a danger of burns and scalds.

State one precaution that the student takes to minimise this risk.

..... [1]

- (c) Calculate the rise in temperature $\Delta\theta_C$ of the cold water. Use the equation shown.

$$\Delta\theta_C = \theta_M - \theta_C$$

$$\Delta\theta_C = \text{.....} \text{ } ^\circ\text{C}$$

Calculate the fall in temperature $\Delta\theta_H$ of the hot water. Use the equation shown.

$$\Delta\theta_H = \theta_H - \theta_M$$

$$\Delta\theta_H = \text{.....} \text{ } ^\circ\text{C}$$

[1]

- (d) Calculate the increase in thermal energy E_C of the cold water. Use the equation shown.

$$E_C = 420 \times \Delta\theta_C$$

$$E_C = \text{.....} \text{ } \text{J}$$

Calculate the decrease in thermal energy E_H of the hot water. Use the equation shown.

$$E_H = 420 \times \Delta\theta_H$$

$$E_H = \text{.....} \text{ } \text{J}$$

[1]

(e) The increase in thermal energy E_C should be equal to the decrease in thermal energy E_H .

Any difference between E_C and E_H is the thermal energy lost by the water when the hot and cold water are mixed.

Calculate the thermal energy lost by the water E_L when the hot and cold water are mixed.

$$E_L = \dots\dots\dots \text{ J [1]}$$

(f) (i) Suggest what has happened to the thermal energy lost by the water.

.....
..... [1]

(ii) State two ways in which this loss of thermal energy can be reduced.

- 1
- 2 [2]

[Total: 10]

Permission to reproduce items where third-party owned material protected by copyright is included has been sought and cleared where possible. Every reasonable effort has been made by the publisher (UCLES) to trace copyright holders, but if any items requiring clearance have unwittingly been included, the publisher will be pleased to make amends at the earliest possible opportunity.

To avoid the issue of disclosure of answer-related information to candidates, all copyright acknowledgements are reproduced online in the Cambridge Assessment International Education Copyright Acknowledgements Booklet. This is produced for each series of examinations and is freely available to download at www.cambridgeinternational.org after the live examination series.

Cambridge Assessment International Education is part of the Cambridge Assessment Group. Cambridge Assessment is the brand name of the University of Cambridge Local Examinations Syndicate (UCLES), which itself is a department of the University of Cambridge.