



CO-ORDINATED SCIENCES

0654/02

Paper 2 Multiple Choice (Extended)

For Examination from 2019

SPECIMEN PAPER

45 minutes

Additional Materials: Multiple Choice Answer Sheet
 Soft clean eraser
 Soft pencil (type B or HB is recommended)

READ THESE INSTRUCTIONS FIRST

Write in soft pencil.

Do not use staples, paper clips, glue or correction fluid.

Write your name, Centre number and candidate number on the Answer Sheet in the spaces provided unless this has been done for you.

DO NOT WRITE IN ANY BARCODES.

There are **forty** questions on this paper. Answer **all** questions. For each question there are four possible answers **A, B, C** and **D**.

Choose the **one** you consider correct and record your choice in **soft pencil** on the separate Answer Sheet.

Read the instructions on the Answer Sheet very carefully.

Each correct answer will score one mark. A mark will not be deducted for a wrong answer.

Any rough working should be done in this booklet.

A copy of the Periodic Table is printed on page 20.

Electronic calculators may be used.

This document consists of **19** printed pages and **1** blank page.

- 1 The diagram shows cells from an organism seen under a light microscope.

Which part shows that the organism **must** be a plant?

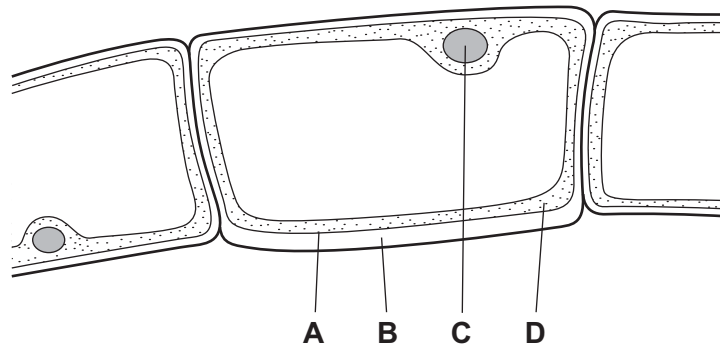

- 2 The diagram shows part of a plant root in the soil. The root is absorbing water.

At which labelled point is the water potential highest?

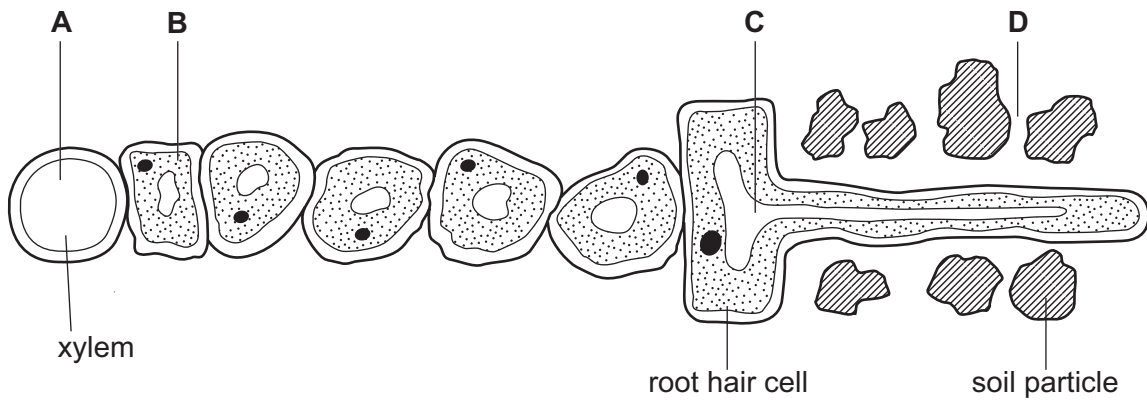

- 3 A student investigates the effect of light on the rate of photosynthesis in an aquatic plant. She draws a graph of her results.

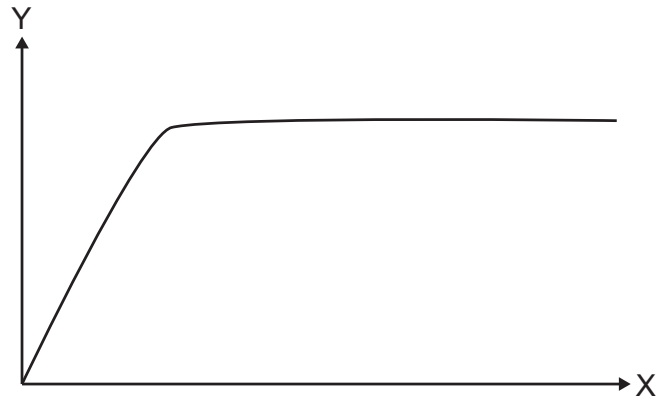

Which labels are correct for axes Y and X?

	Y	X
A	volume of carbon dioxide produced	distance of light from plant
B	volume of carbon dioxide produced	light intensity
C	volume of oxygen produced	distance of light from plant
D	volume of oxygen produced	light intensity

- 4 The diagram shows the alimentary canal of a dog.

Where does egestion occur?

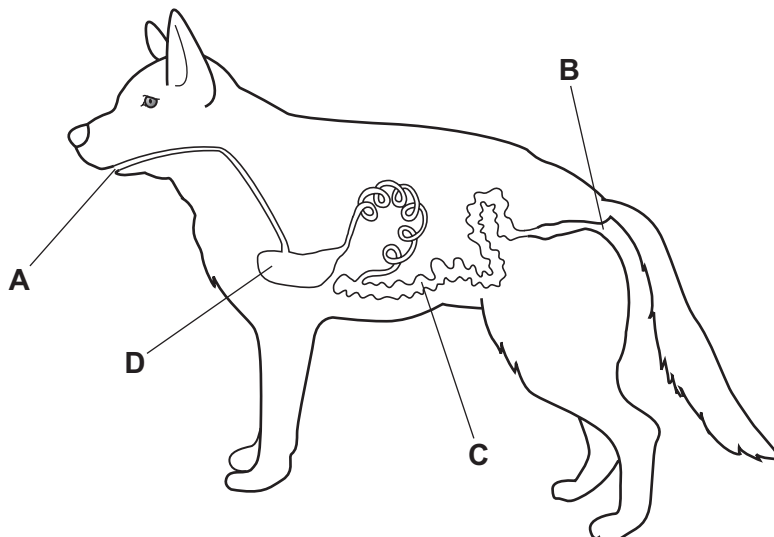

- 5 Coronary heart disease may lead to a person having a heart attack. The diagram shows a human heart and some of its major blood vessels.

Which labelled part can cause a heart attack if it becomes blocked?

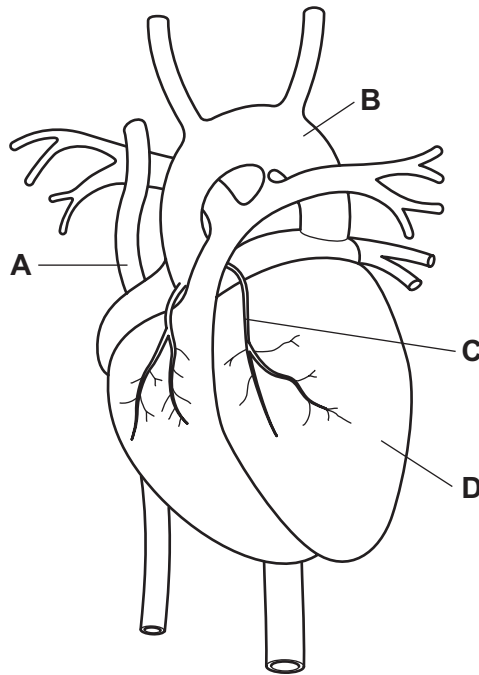

- 6 The table shows some features of respiration.

Which row is correct for anaerobic respiration?

	amount of energy released per glucose molecule	reaction produces lactic acid	reaction releases carbon dioxide
A	high	always	sometimes
B	high	sometimes	always
C	low	always	always
D	low	sometimes	sometimes

- 7 The diagram shows a section through a human eye.
The eye focuses on a close object.

Which row describes what happens to P and the effect on Q?

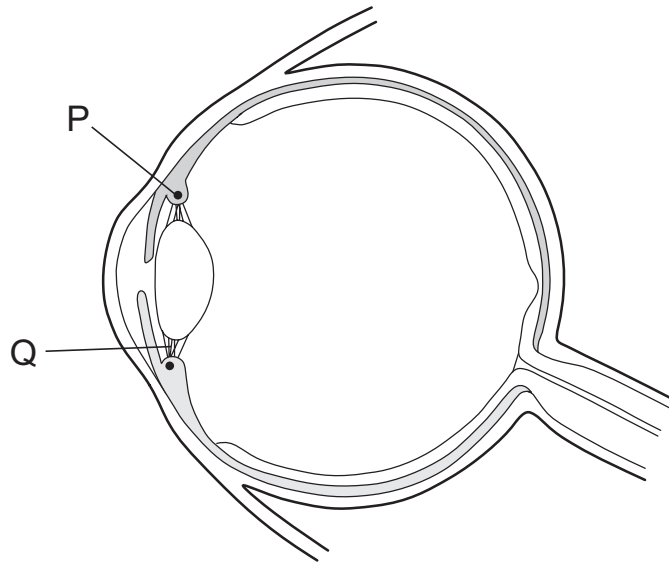

	P	Q
A	contracts	slackens
B	contracts	tightens
C	relaxes	slackens
D	relaxes	tightens

- 8 Which of these processes best describes homeostasis?
- A** breathing faster after exercise
 - B** keeping internal conditions in the body constant
 - C** preventing the body from getting too hot
 - D** removing of carbon dioxide from the lungs
- 9 Which feature of sexual reproduction helps a species to evolve?
- A** Any offspring produced will always be in a suitable environment.
 - B** Fewer offspring are produced than in asexual reproduction.
 - C** Offspring always inherit advantageous characteristics.
 - D** Offspring are the result of the fusion of genetically different gametes.

10 Pollination is the transfer of pollen

- A from anther to sepal.
- B from anther to stigma.
- C from sepal to anther.
- D from stigma to anther.

11 A cell of an organism is formed by meiosis. The nucleus of this cell contains 20 chromosomes.

What is the diploid chromosome number for this organism?

- A 10
- B 20
- C 40
- D 46

12 In mice, the allele for black fur is dominant to the allele for white fur. Two heterozygous mice mate.

What colour are the offspring likely to be?

- A all black
- B all grey
- C all white
- D some black and some white

13 The diagram shows a food web in an Arctic ecosystem.

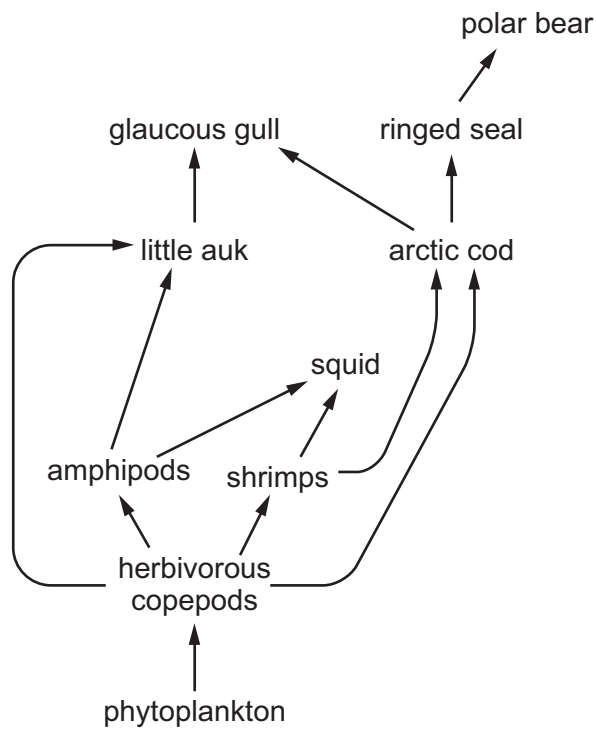

How many organisms can act as tertiary consumers in this food web?

- A 3
- B 4
- C 5
- D 6

14 Hydrogen can occur as an atom, an ion and a molecule.

Which row in the table represents these particles?

	atom	ion	molecule
A	H	H ⁺	H ₂
B	H	H ₂	H ⁺
C	H ⁺	H	H ₂
D	H ₂	H ⁺	H

- 15 Small amounts of sodium chloride and sand are shaken with separate samples of water in two test-tubes. The test-tubes are left to stand for 24 hours.

Which diagram shows how the test-tubes appear after leaving them to stand for 24 hours?

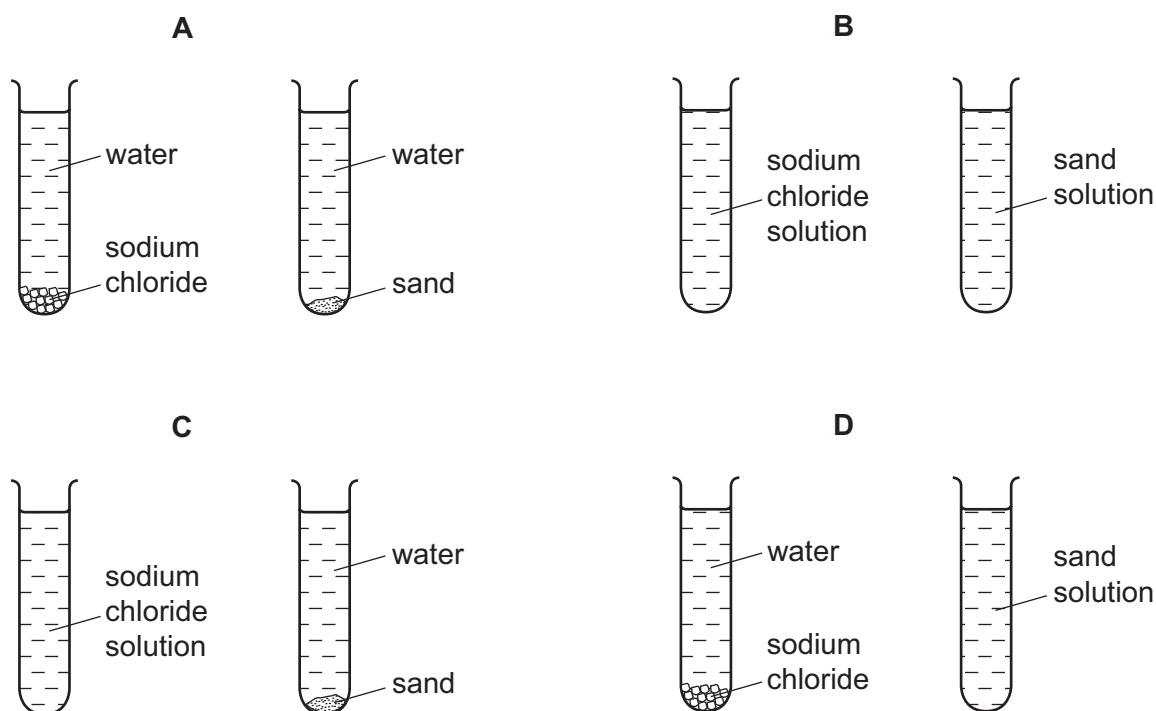

- 16 What is the dot-and-cross diagram for a molecule of carbon dioxide?

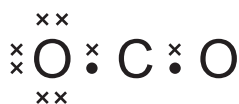

A



B

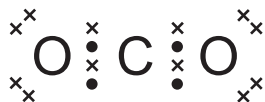

C

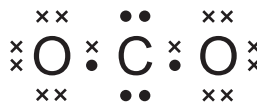

D

- 17 Which substances are produced during the electrolysis of concentrated aqueous sodium chloride?

- A chlorine, hydrogen and sodium
- B chlorine, hydrogen and sodium hydroxide
- C hydrogen and oxygen
- D oxygen and sodium hydroxide

18 Which statement describes an exothermic process?

- A There is a temperature decrease as bonds break.
- B There is a temperature decrease as bonds form.
- C There is a temperature increase as bonds break.
- D There is a temperature increase as bonds form.

19 The apparatus below is used to investigate the rate of a chemical reaction.

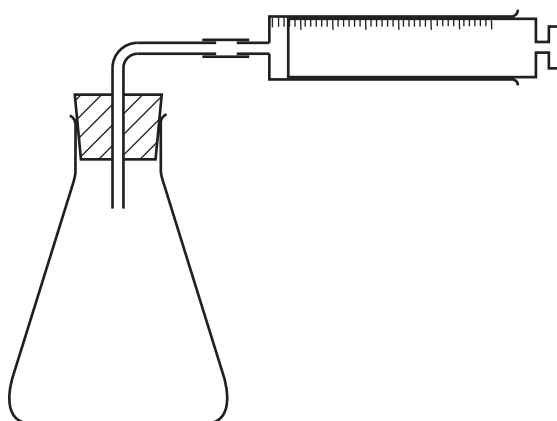

For which reaction is the apparatus used to investigate the rate of reaction?

- A $\text{gas E} + \text{gas F} \rightarrow \text{liquid G}$
 - B $\text{solid H} + \text{solution I} \rightarrow \text{solution J}$
 - C $\text{solid K} + \text{solution L} \rightarrow \text{solution M} + \text{gas N}$
 - D $\text{solution P} + \text{solution Q} \rightarrow \text{solid R} + \text{solution Q}$
- 20 Which equation shows a redox reaction?
- A $\text{AgNO}_3(\text{aq}) + \text{NaCl}(\text{aq}) \rightarrow \text{AgCl}(\text{s}) + \text{NaNO}_3(\text{aq})$
 - B $\text{BaCl}_2(\text{aq}) + \text{H}_2\text{SO}_4(\text{aq}) \rightarrow \text{BaSO}_4(\text{s}) + 2\text{HCl}(\text{aq})$
 - C $2\text{Na}(\text{s}) + \text{Cl}_2(\text{g}) \rightarrow 2\text{NaCl}(\text{s})$
 - D $\text{NaOH}(\text{aq}) + \text{HCl}(\text{aq}) \rightarrow \text{NaCl}(\text{aq}) + \text{H}_2\text{O}(\text{l})$

21 The elements from sodium to sulfur, shown below, are in the same period of the Periodic Table.

Na	Mg	Al	Si	P	S
----	----	----	----	---	---

Which trend does **not** occur across the Periodic Table from sodium to sulfur?

- A The chlorides of the elements change from covalent to ionic.
- B The elements change from good to poor electrical conductors.
- C The oxides of the elements change from basic to acidic.
- D The solid elements change from malleable to brittle.

22 Astatine, At, is below iodine in Group VII of the Periodic Table.

Cl
Br
I
At

The properties of astatine can be predicted by comparison with the properties of the other Group VII elements.

Which statement about astatine is **not** correct?

- A It displaces bromine from potassium bromide.
- B It exists as At_2 molecules.
- C It has a dark grey or black colour.
- D It is solid at room temperature.

23 A cup is made of copper.

Why is the cup **not** used for hot drinks?

- A Copper is a good conductor of heat.
- B Copper is a good electrical conductor.
- C Copper is brightly coloured.
- D Copper is malleable.

24 Why is chlorine used in the treatment of the water supply?

- A to improve the taste
- B to kill microorganisms
- C to neutralise acids
- D to remove solids

25 Which compounds are formed during the Contact process?

- A H_2SO_4 only
- B NH_3
- C SO_2 and SO_3 only
- D SO_2 , SO_3 and H_2SO_4

26 Petroleum is separated into useful fractions by fractional distillation.

Which row in the table describes the properties of the compounds in the fraction obtained from the bottom of the fractionating column?

	boiling point	molecular size	intermolecular attractive forces
A	high	large	strong
B	high	small	weak
C	low	large	weak
D	low	small	strong

27 Which compound **cannot** be formed by reacting ethene, C_2H_4 , with one other substance?

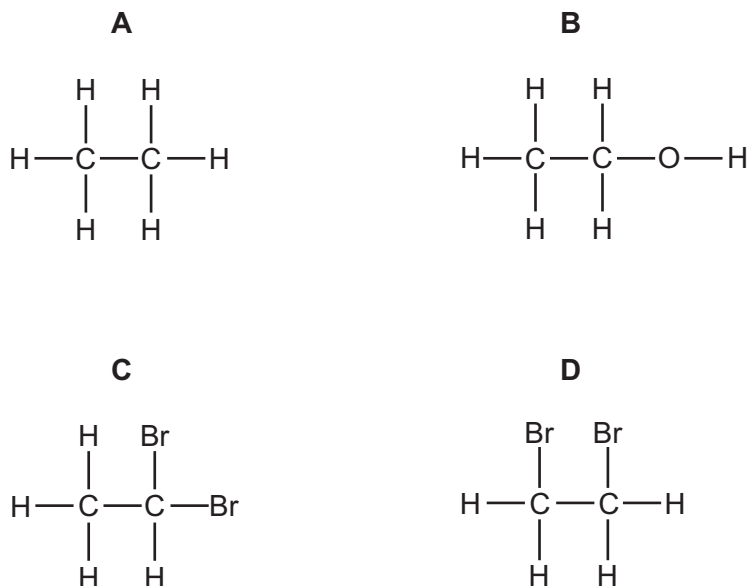

28 The diagrams show different weights resting on wooden blocks. All the wooden blocks have the same dimensions and weight.

In which diagram is the greatest pressure exerted on the ground?

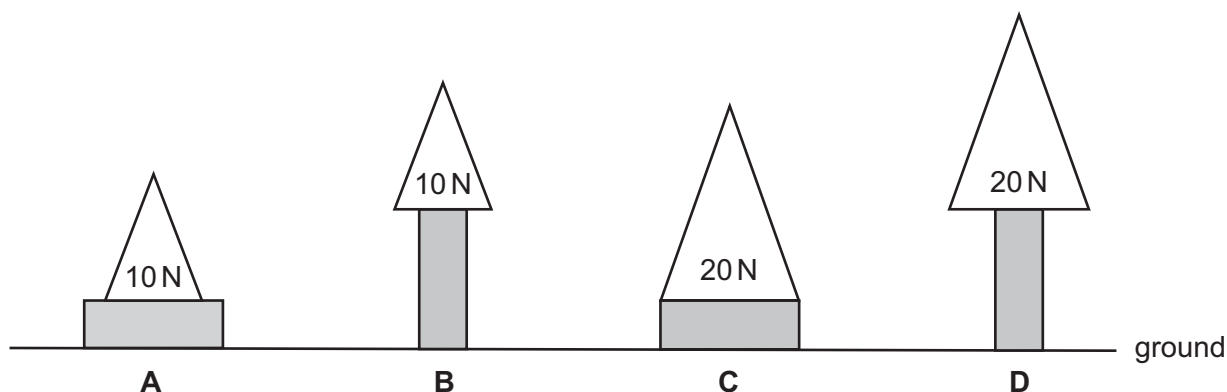

29 A stone of mass 0.10 kg is thrown vertically upwards at a speed of 4.0 m/s.

What maximum height does it reach?

Air resistance can be ignored. The acceleration of free fall g is 10 m/s^2 .

- A 0.40 m
- B 0.80 m
- C 10 m
- D 40 m

- 30 The table lists four energy resources. For each resource it states if the energy resource was originally derived from the Sun's energy.

Which row contains an **error**?

	energy resource	derived from the Sun's energy
A	geothermal	no
B	hydroelectric	no
C	oil	yes
D	waves	yes

- 31 Molecules escape from a liquid as it evaporates.

Which row in the table describes the energy of the molecules that escape and the effect on the temperature of the remaining liquid?

	molecules that escape	effect on temperature of remaining liquid
A	high energy	decreases
B	high energy	increases
C	low energy	decreases
D	low energy	increases

32 The diagram shows some ice being used to lower the temperature of some warm water.

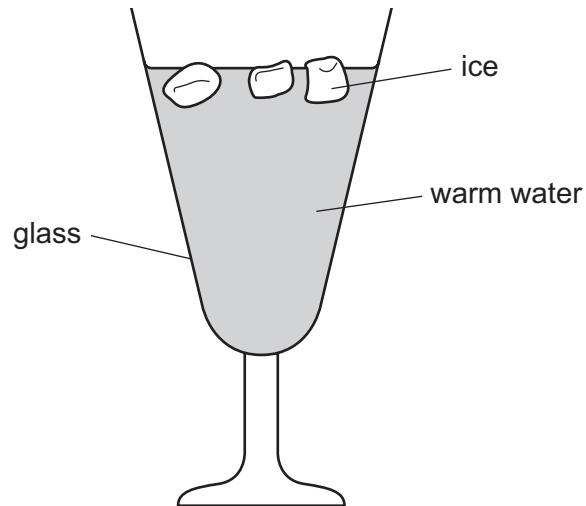

What is the main process by which the water at the bottom of the glass becomes cool?

- A condensation
- B conduction
- C convection
- D radiation

33 An object O is placed close to a thin converging lens.

The diagram represents three rays from the top of O passing through the lens.

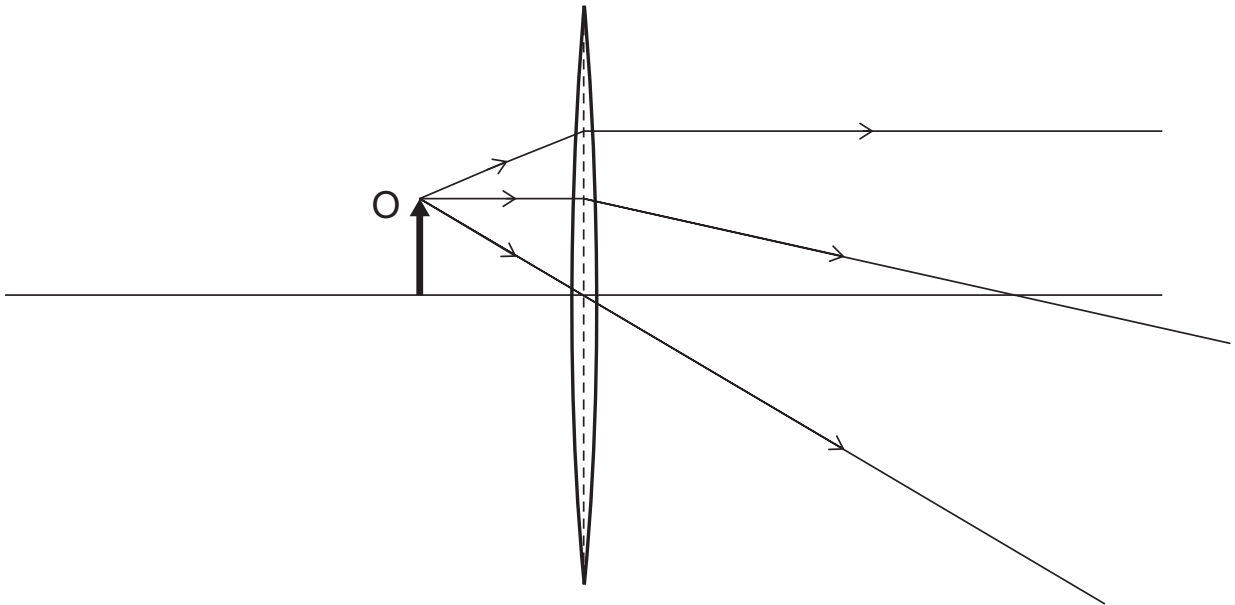

Which type of image is produced by the lens when the object O is in this position?

- A real and diminished
 - B real and enlarged
 - C virtual and diminished
 - D virtual and enlarged
- 34 Which row shows how the speed and the wavelength of microwaves compare with the speed and the wavelength of X-rays?

	speed of microwaves	wavelength of microwaves
A	less than X-rays	greater than X-rays
B	less than X-rays	less than X-rays
C	the same as X-rays	greater than X-rays
D	the same as X-rays	less than X-rays

35 Which is an example of a longitudinal wave?

- A infra-red
- B light
- C radio
- D sound

36 A copper wire has resistance R .

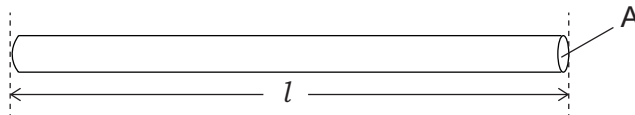

A second copper wire is twice as long as the first wire, and has twice the cross-sectional area.

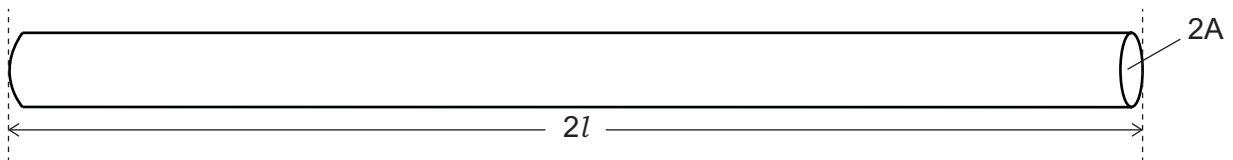

What is the resistance of the second copper wire?

- A $0.5R$
- B R
- C $2R$
- D $4R$

37 A $24\ \Omega$ resistor and a $12\ \Omega$ resistor are connected in parallel.

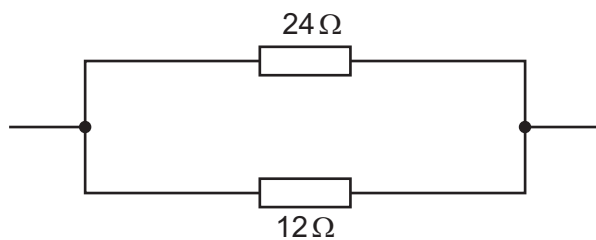

What is their combined resistance?

- A $2.0\ \Omega$
- B $8.0\ \Omega$
- C $18\ \Omega$
- D $36\ \Omega$

38 The diagram shows a wire placed between two magnetic poles of equal strength.

There is a current in the wire in the direction shown. The current causes a downward force on the wire.

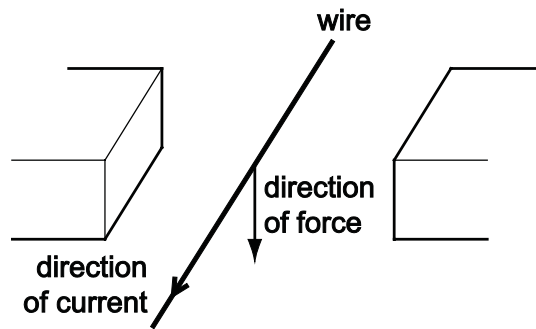

What is the arrangement of the magnetic poles?

A



B



C



D

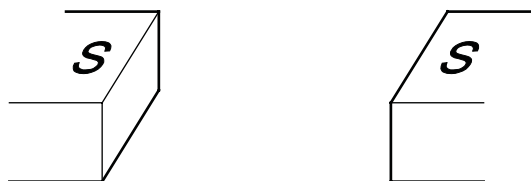

- 39 A 100% efficient transformer has 500 turns on its primary coil and 1000 turns on its secondary coil. The input voltage is 12V and the output current is 2.0 A.

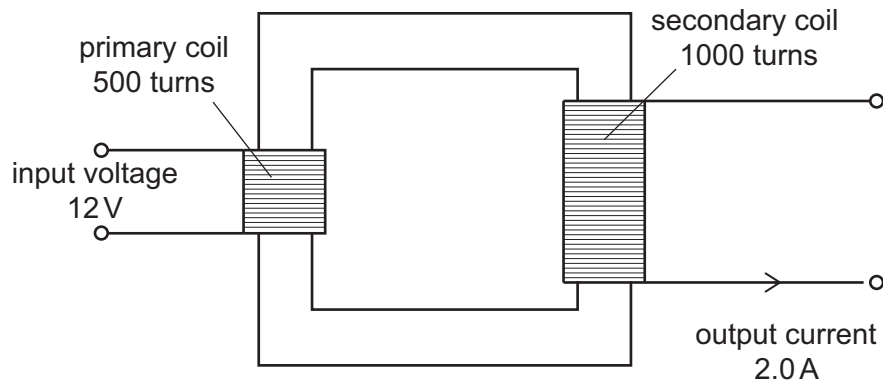

What is the output power of the transformer?

- A 12W
 - B 24W
 - C 48W
 - D 96W
- 40 A powder contains 2.4g of a radioactive isotope.

The half-life of the isotope is 2.0 days.

What mass of this isotope remains after 6.0 days?

- A 0g
- B 0.30g
- C 0.80g
- D 1.2g

The Periodic Table of Elements

Group																							
I	II											III	IV	V	VI	VII	VIII						
												1 H hydrogen 1											2 He helium 4
												Key atomic number atomic symbol name relative atomic mass						5 B boron 11	6 C carbon 12	7 N nitrogen 14	8 O oxygen 16	9 F fluorine 19	10 Ne neon 20
3 Li lithium 7	4 Be beryllium 9											13 Al aluminium 27	14 Si silicon 28	15 P phosphorus 31	16 S sulfur 32	17 Cl chlorine 35.5	18 Ar argon 40						
19 K potassium 39	20 Ca calcium 40	21 Sc scandium 45	22 Ti titanium 48	23 V vanadium 51	24 Cr chromium 52	25 Mn manganese 55	26 Fe iron 56	27 Co cobalt 59	28 Ni nickel 59	29 Cu copper 64	30 Zn zinc 65	31 Ga gallium 70	32 Ge germanium 73	33 As arsenic 75	34 Se selenium 79	35 Br bromine 80	36 Kr krypton 84						
37 Rb rubidium 85	38 Sr strontium 88	39 Y yttrium 89	40 Zr zirconium 91	41 Nb niobium 93	42 Mo molybdenum 96	43 Tc technetium –	44 Ru ruthenium 101	45 Rh rhodium 103	46 Pd palladium 106	47 Ag silver 108	48 Cd cadmium 112	49 In indium 115	50 Sn tin 119	51 Sb antimony 122	52 Te tellurium 128	53 I iodine 127	54 Xe xenon 131						
55 Cs caesium 133	56 Ba barium 137	57–71 lanthanoids	72 Hf hafnium 178	73 Ta tantalum 181	74 W tungsten 184	75 Re rhenium 186	76 Os osmium 190	77 Ir iridium 192	78 Pt platinum 195	79 Au gold 197	80 Hg mercury 201	81 Tl thallium 204	82 Pb lead 207	83 Bi bismuth 209	84 Po polonium –	85 At astatine –	86 Rn radon –						
87 Fr francium –	88 Ra radium –	89–103 actinoids	104 Rf rutherfordium –	105 Db dubnium –	106 Sg seaborgium –	107 Bh bohrium –	108 Hs hassium –	109 Mt meitnerium –	110 Ds darmstadtium –	111 Rg roentgenium –	112 Cn copernicium –			114 Fl flerovium –			116 Lv livermorium –						

lanthanoids	57 La lanthanum 139	58 Ce cerium 140	59 Pr praseodymium 141	60 Nd neodymium 144	61 Pm promethium –	62 Sm samarium 150	63 Eu europium 152	64 Gd gadolinium 157	65 Tb terbium 159	66 Dy dysprosium 163	67 Ho holmium 165	68 Er erbium 167	69 Tm thulium 169	70 Yb ytterbium 173	71 Lu lutetium 175
actinoids	89 Ac actinium –	90 Th thorium 232	91 Pa protactinium 231	92 U uranium 238	93 Np neptunium –	94 Pu plutonium –	95 Am americium –	96 Cm curium –	97 Bk berkelium –	98 Cf californium –	99 Es einsteinium –	100 Fm fermium –	101 Md mendelevium –	102 No nobelium –	103 Lr lawrencium –

The volume of one mole of any gas is 24 dm³ at room temperature and pressure (r.t.p.).

Permission to reproduce items where third-party owned material protected by copyright is included has been sought and cleared where possible. Every reasonable effort has been made by the publisher (UCLES) to trace copyright holders, but if any items requiring clearance have unwittingly been included, the publisher will be pleased to make amends at the earliest possible opportunity.

Cambridge International Examinations is part of the Cambridge Assessment Group. Cambridge Assessment is the brand name of University of Cambridge Local Examinations Syndicate (UCLES), which is itself a department of the University of Cambridge.